

b



e



d



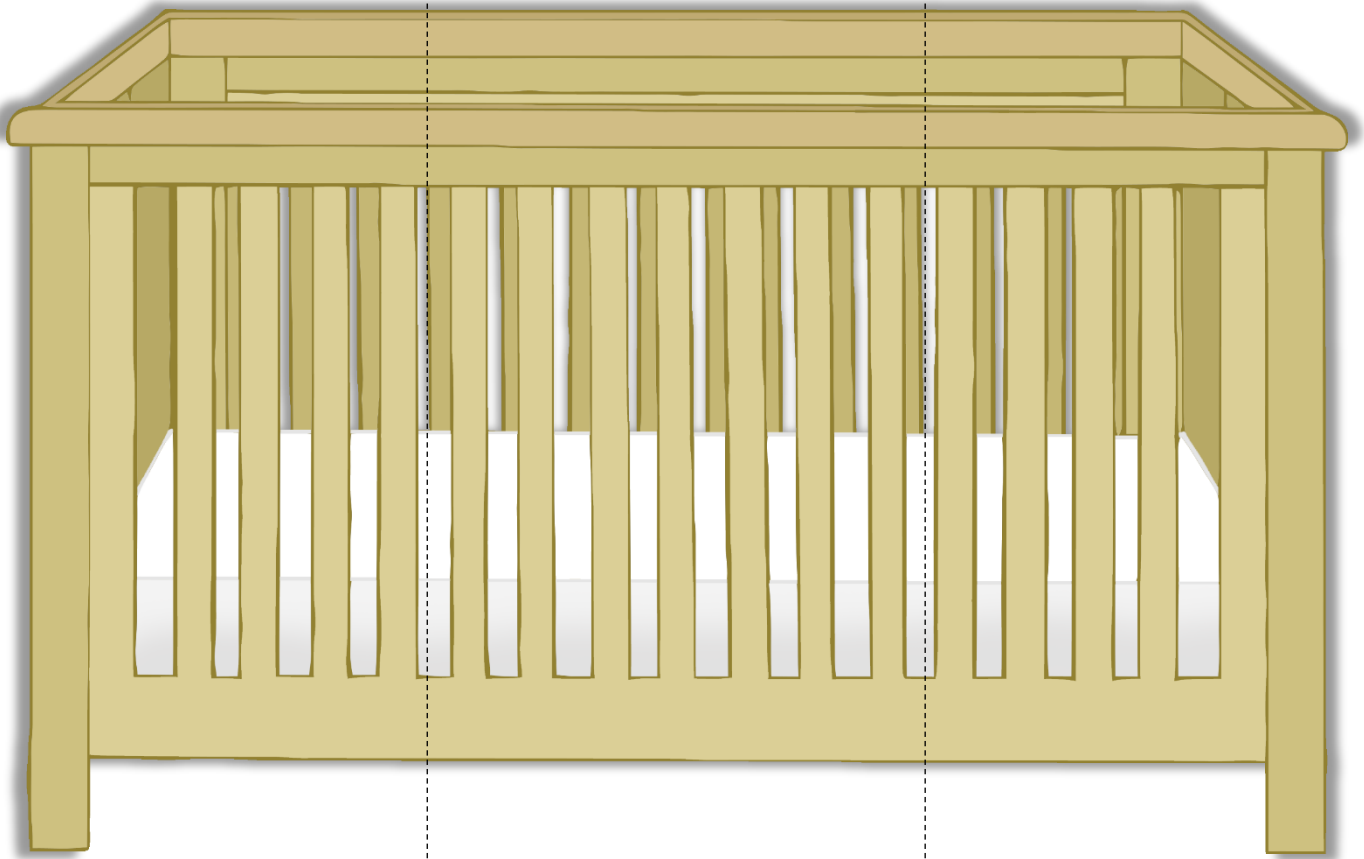

c



o



t



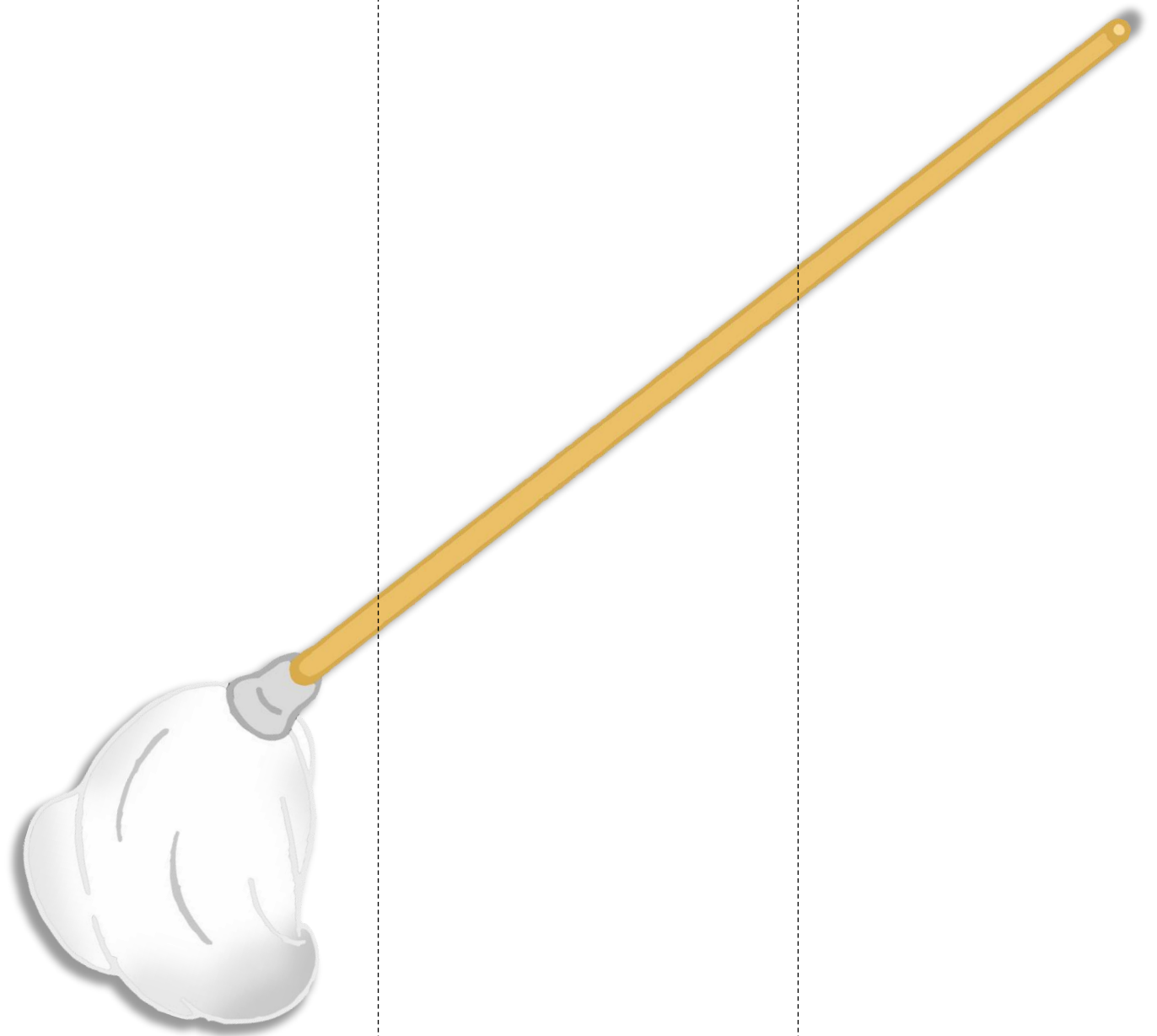

m



o



p



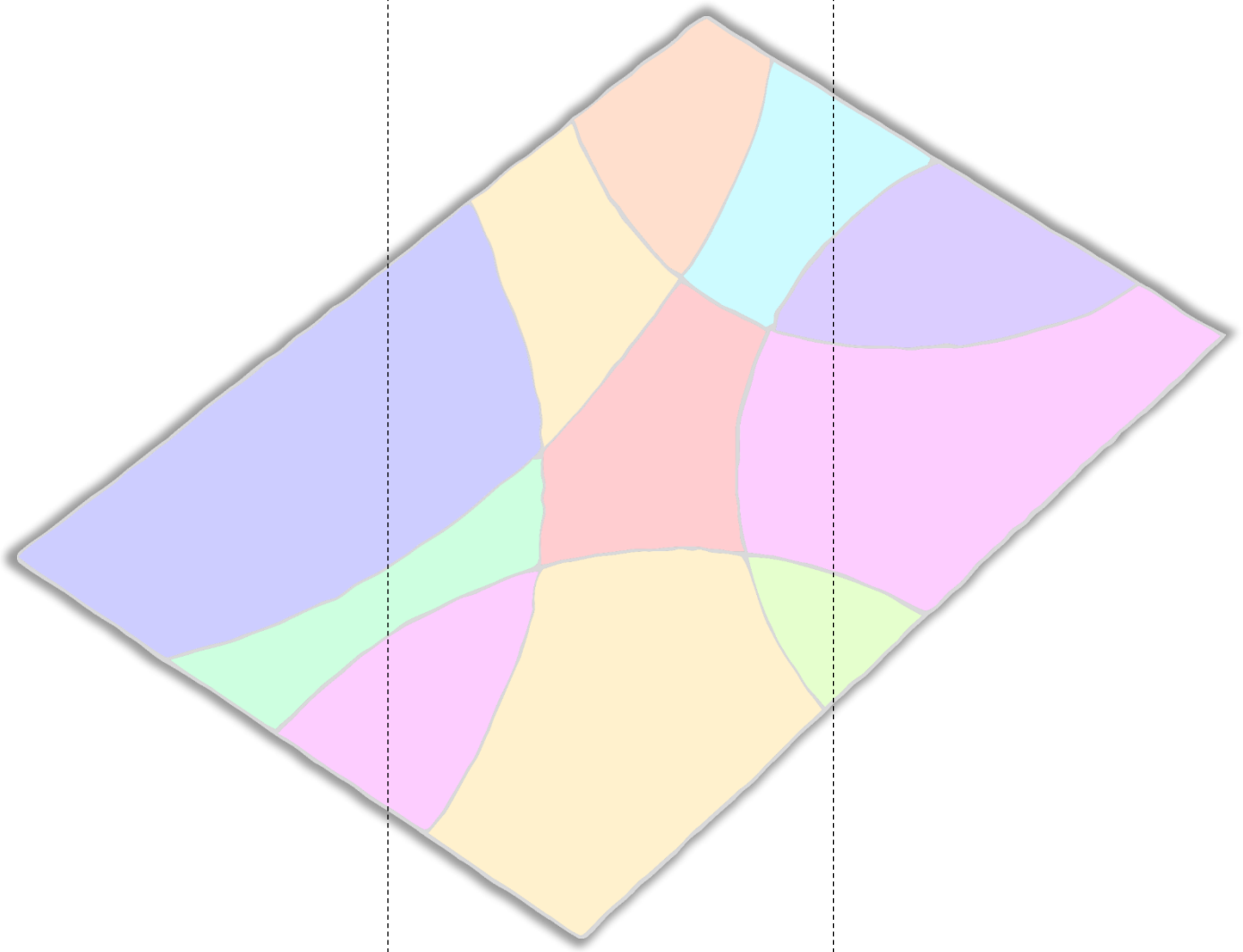

r  
•

u  
•

g  
•

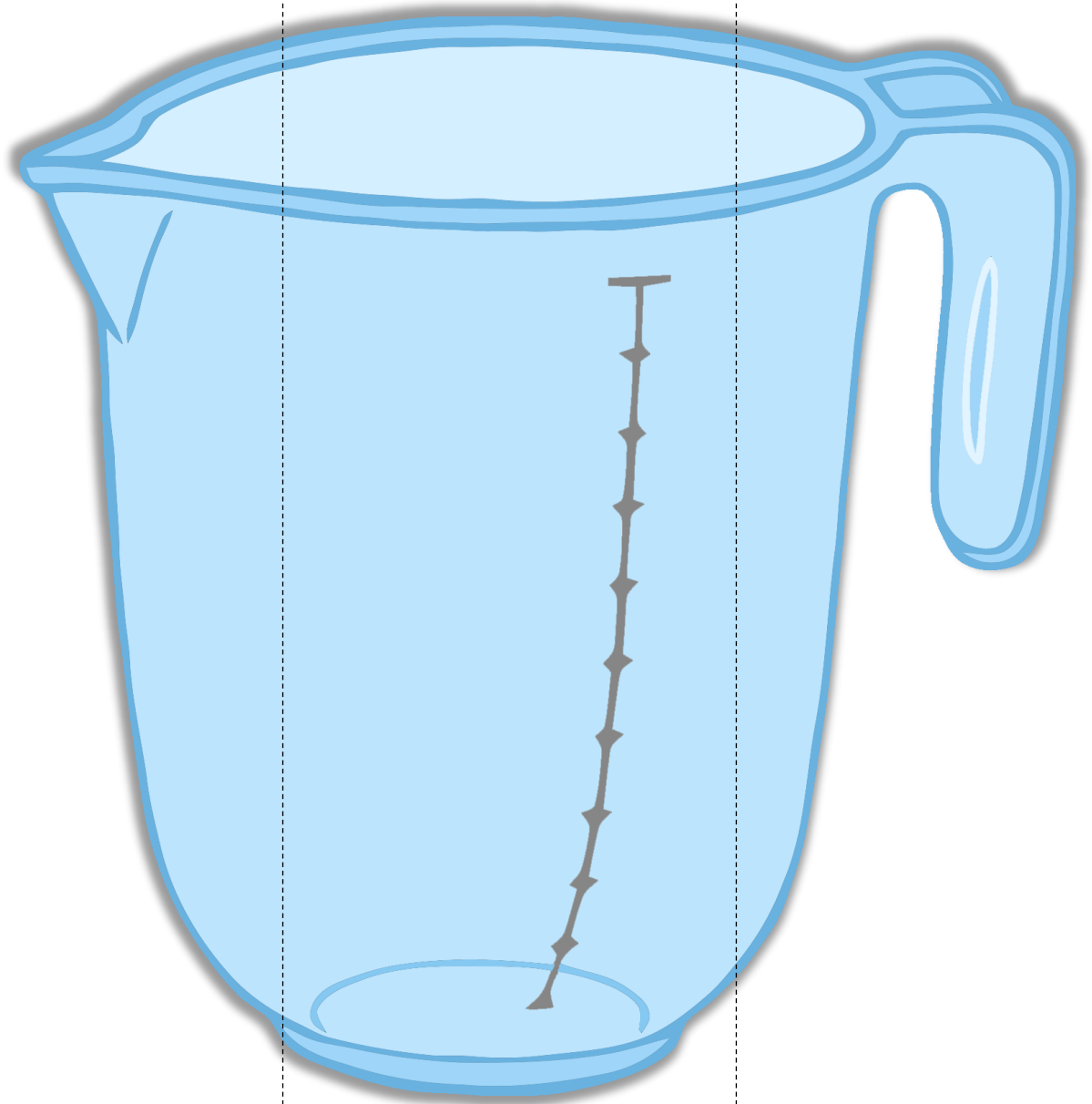

j

u

g

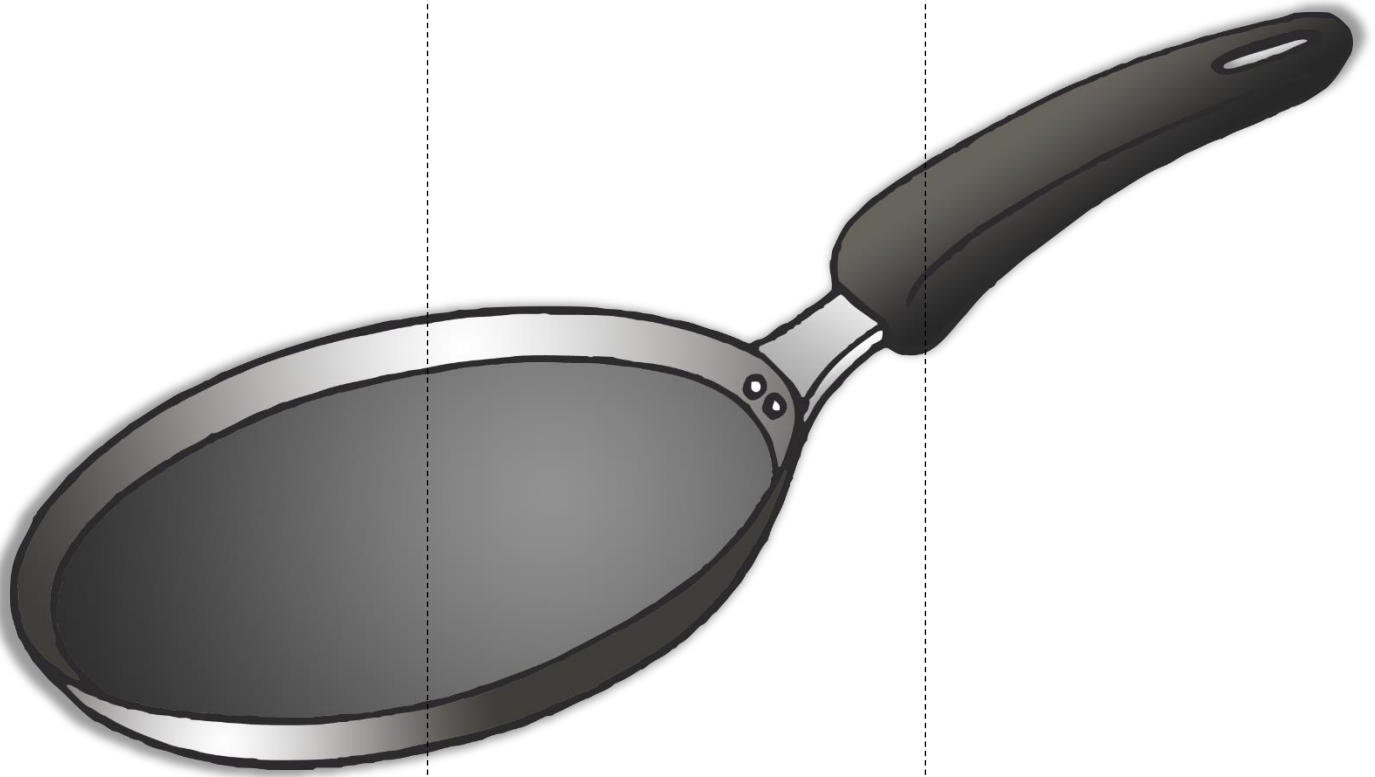

p

a

n

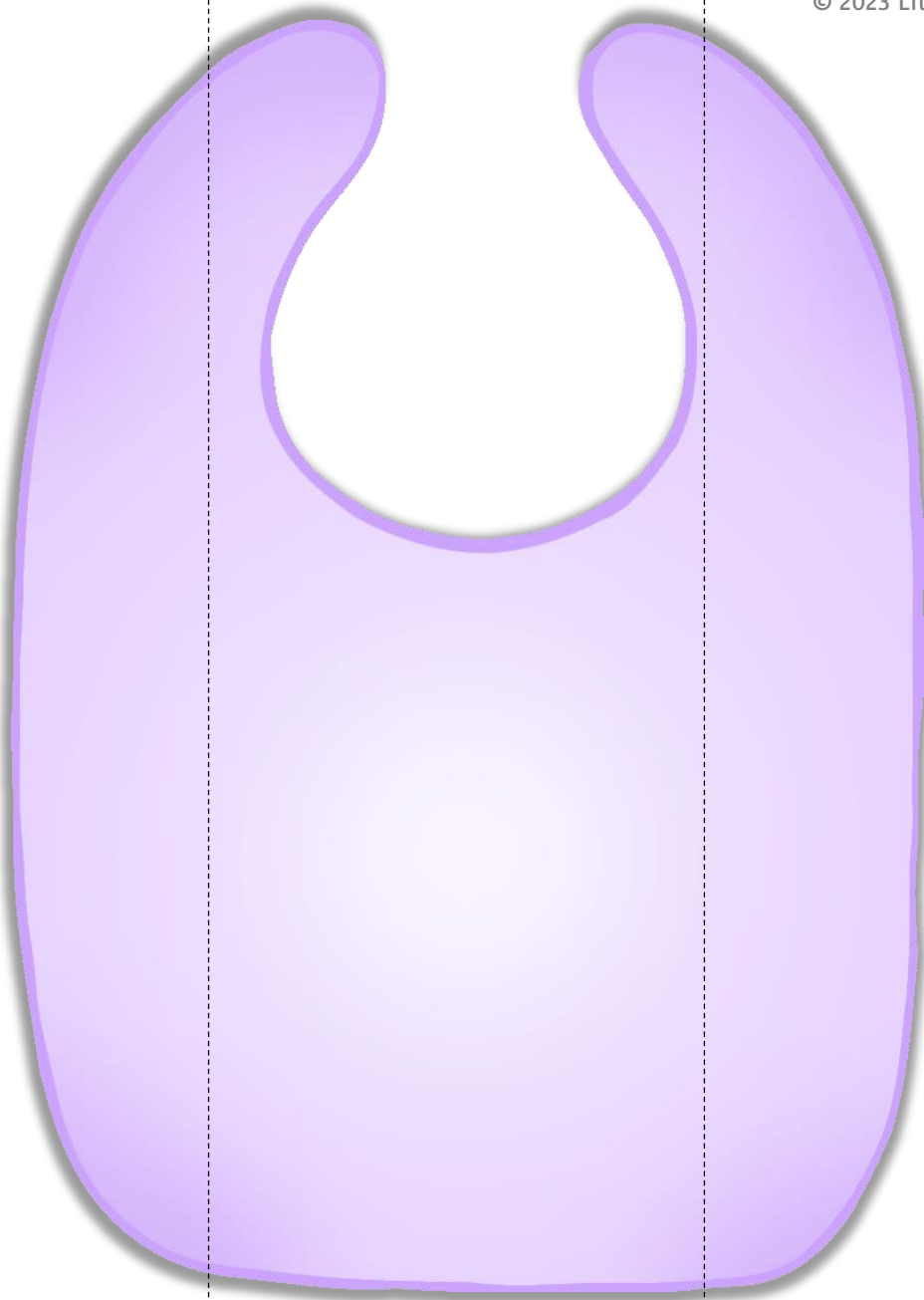

**b**



**i**



**b**





m



u



g





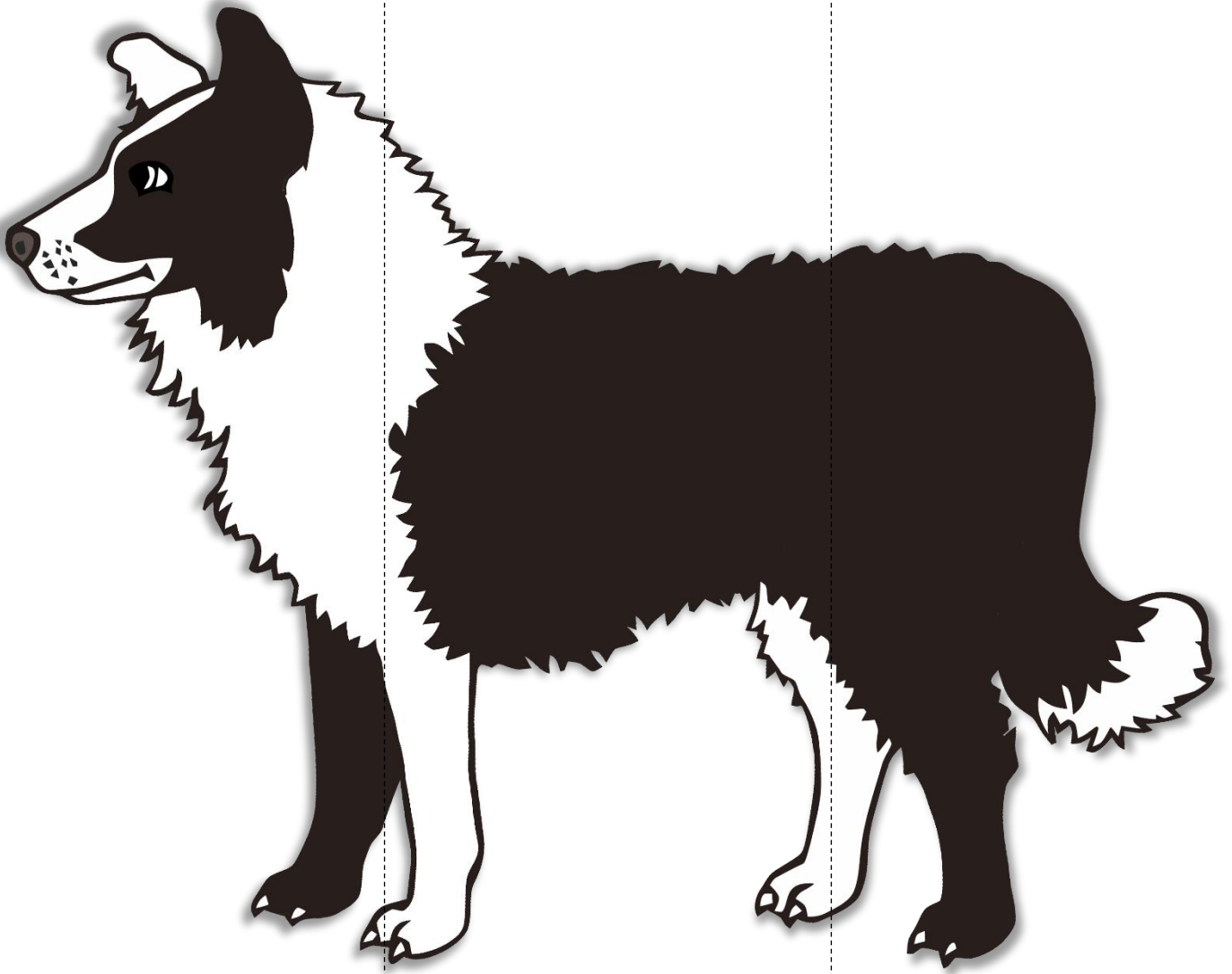

d



o



g



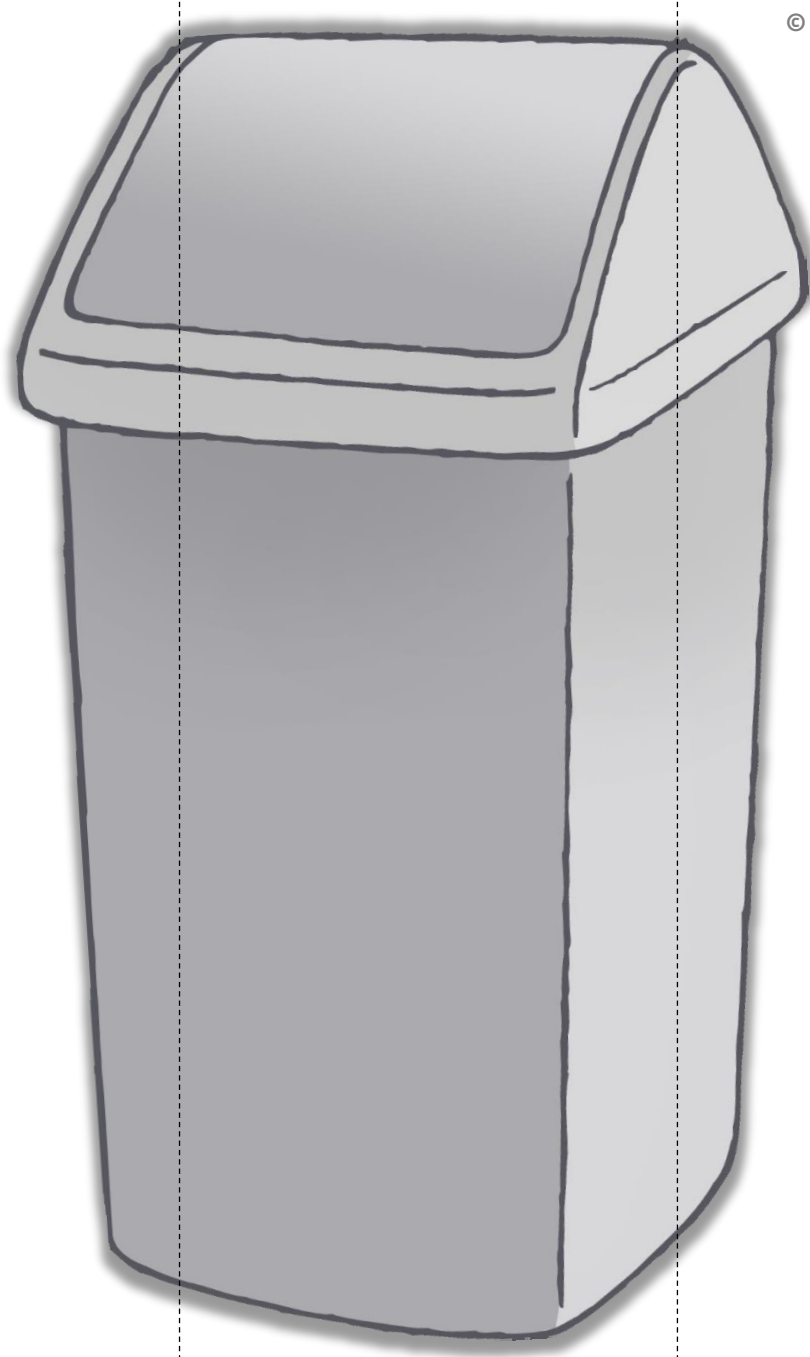

**b**

•

**i**

•

**n**

•

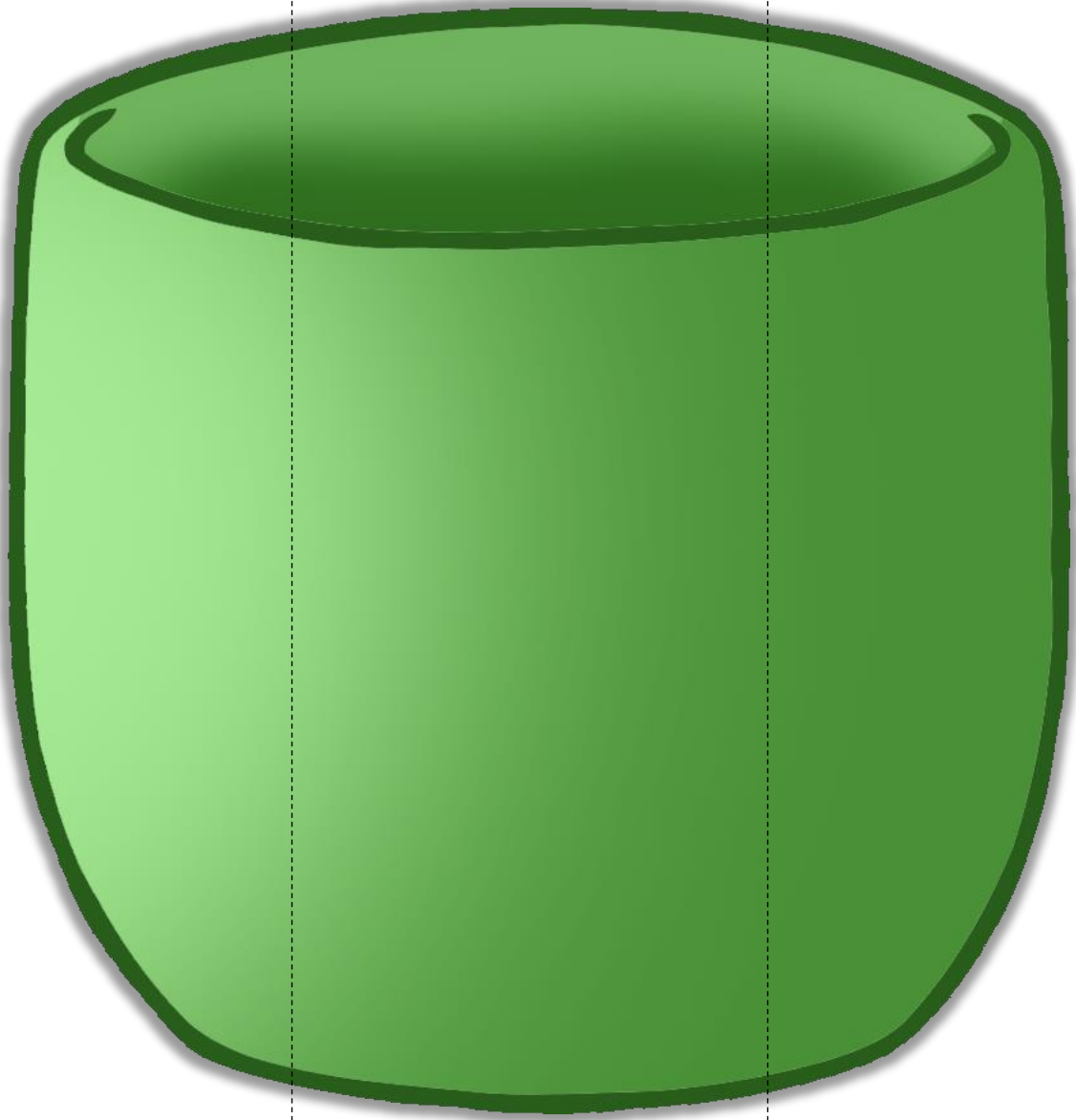

p

o

t

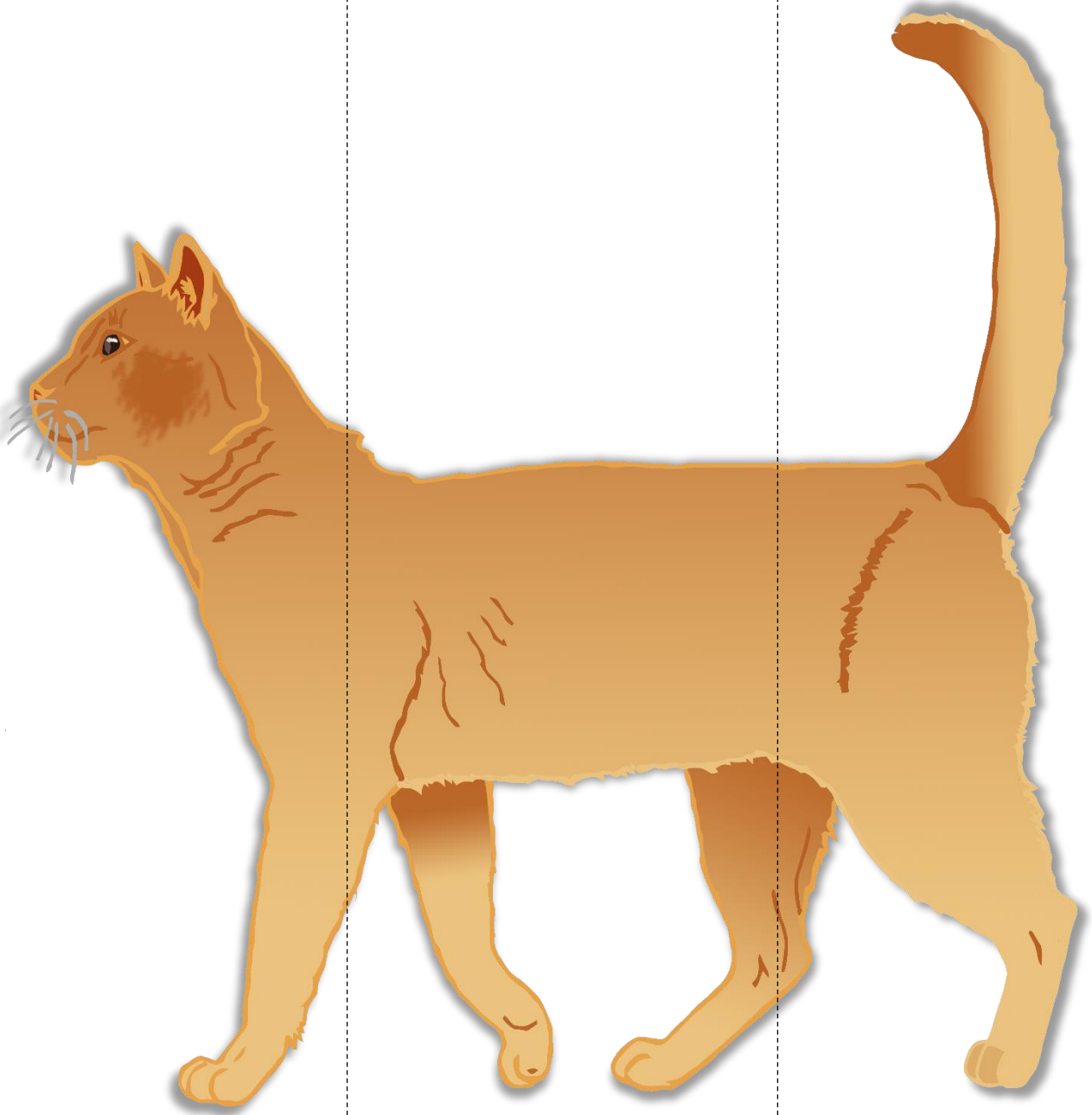

c



a



t



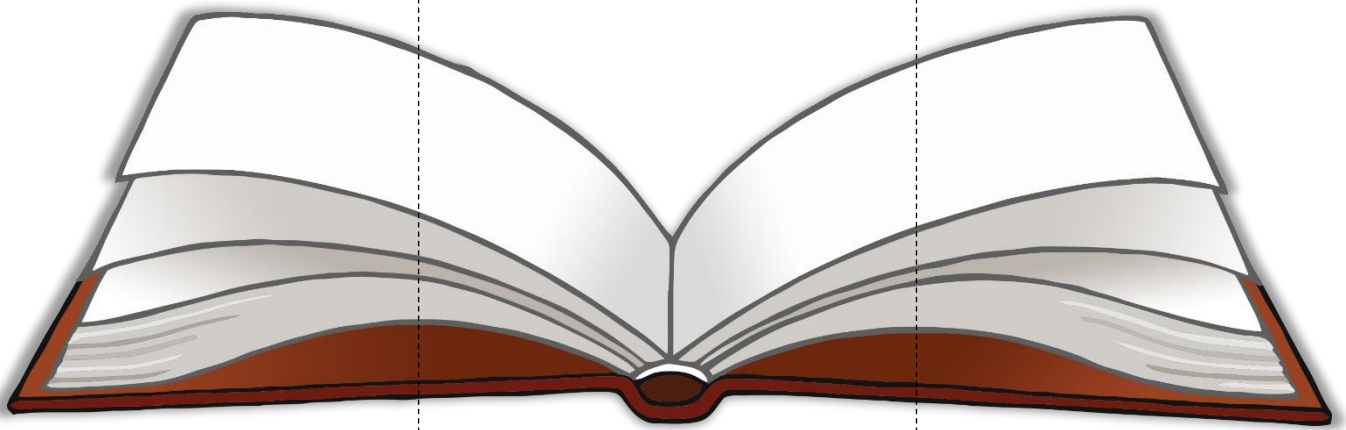

b



oo



k



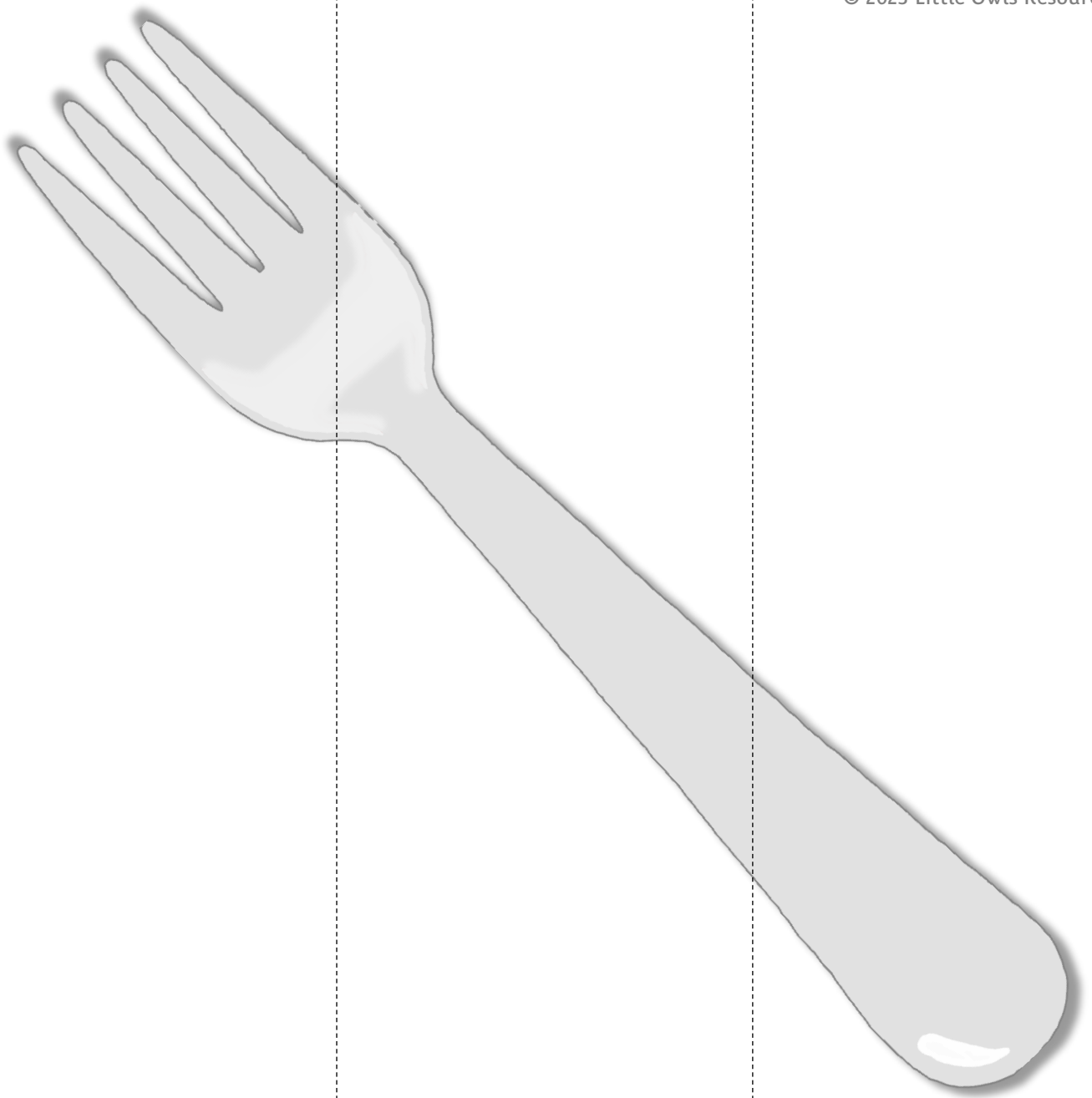

f

or

k

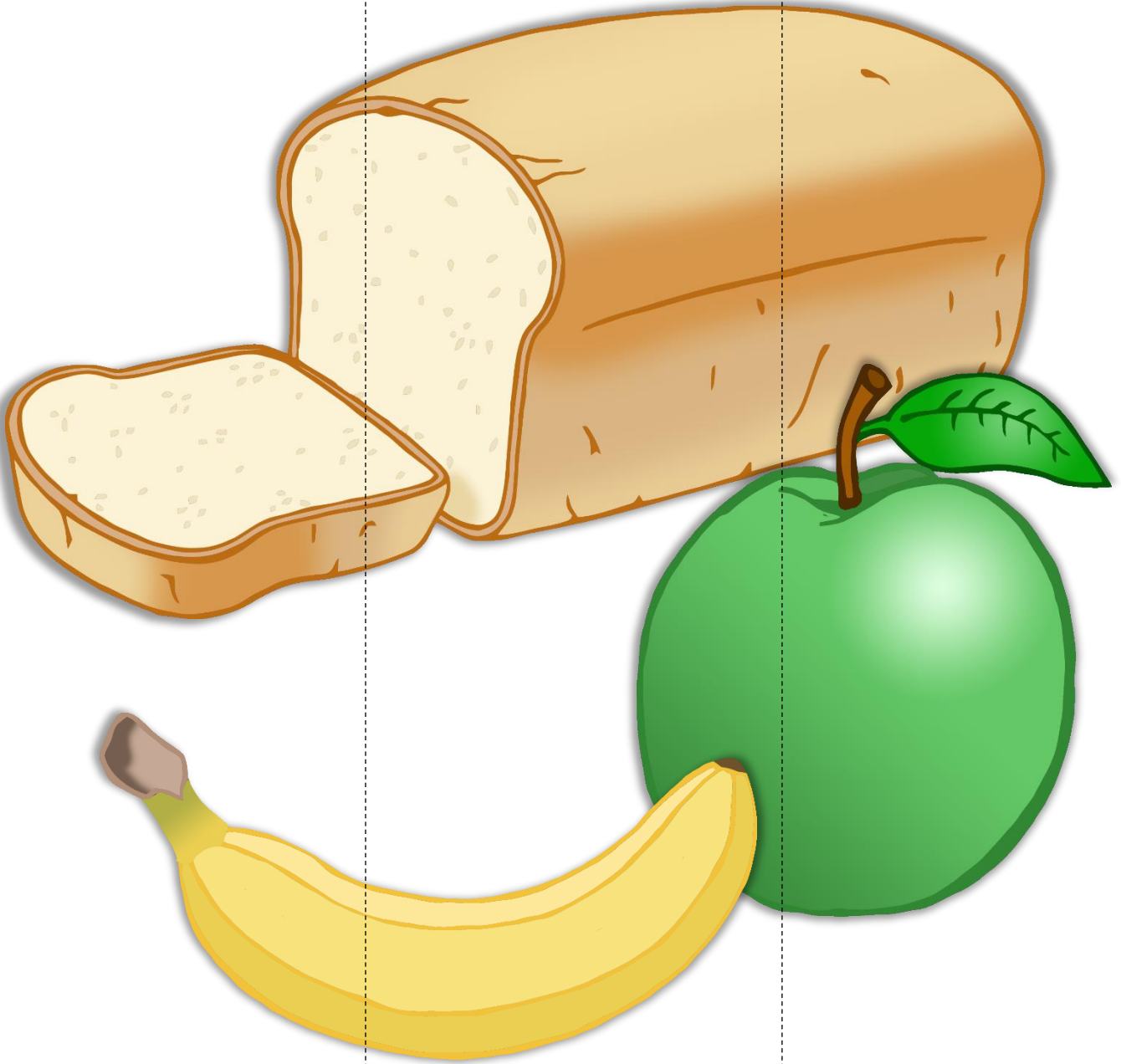

f

oo

d

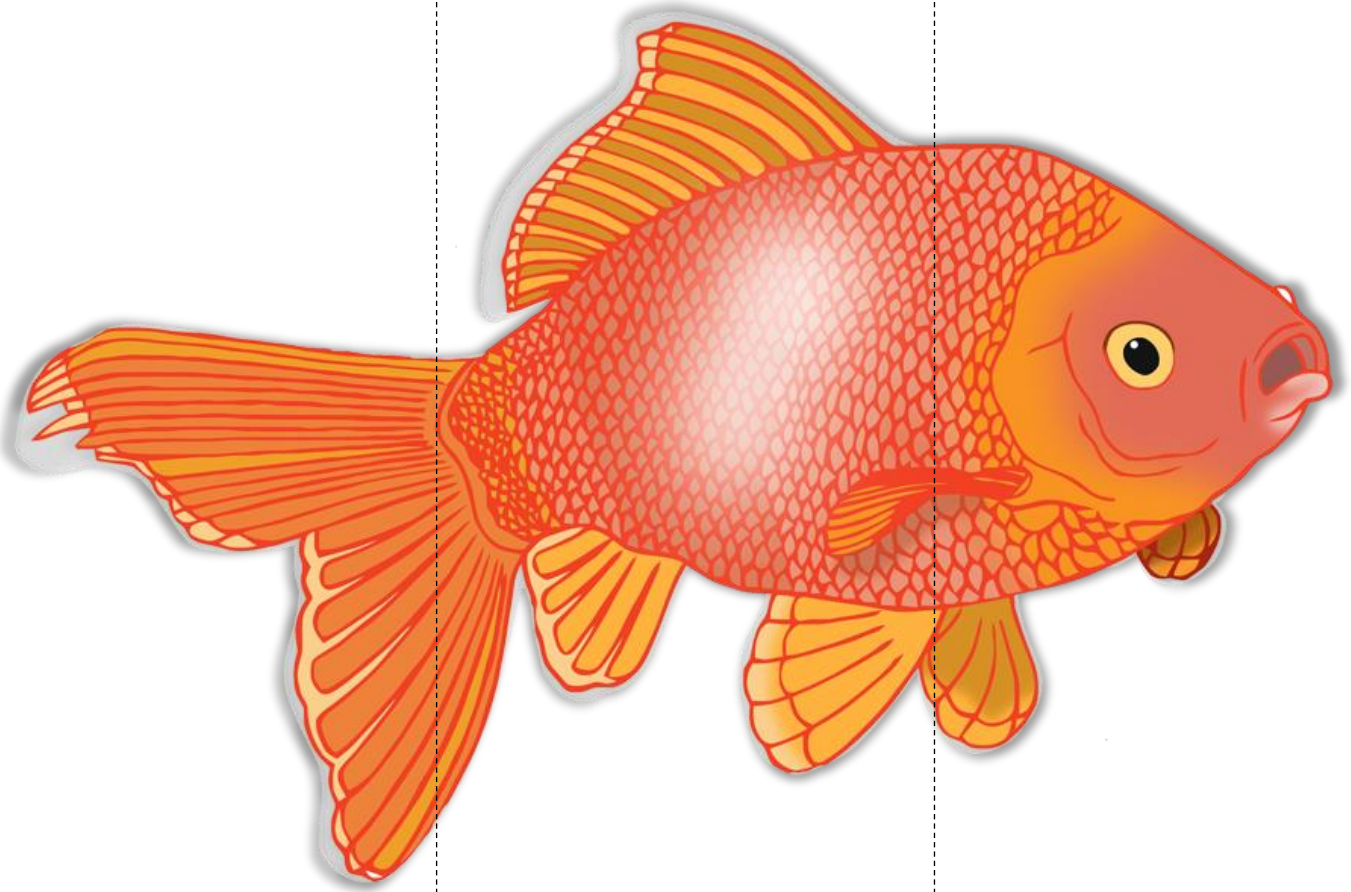

f

i

sh



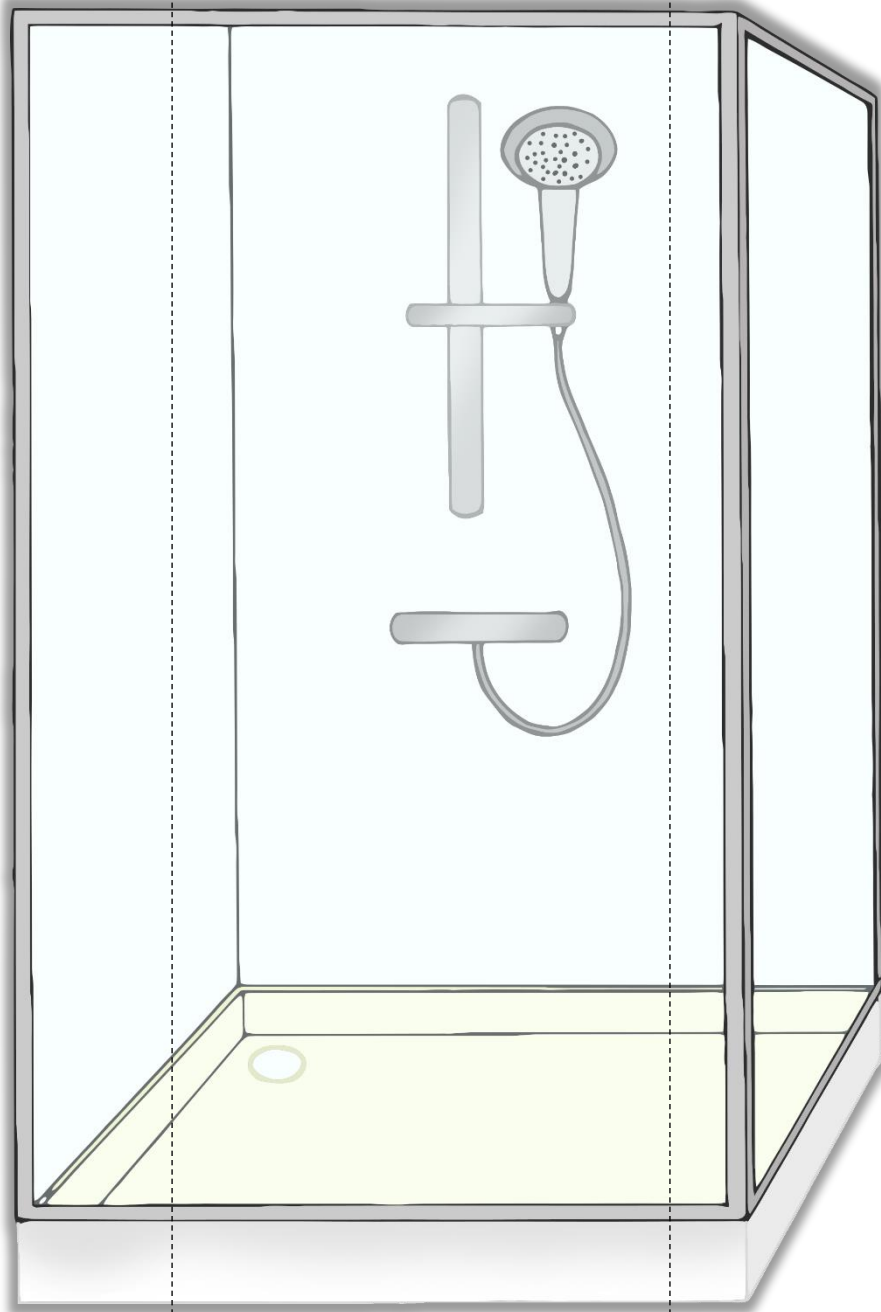

sh

ow

er



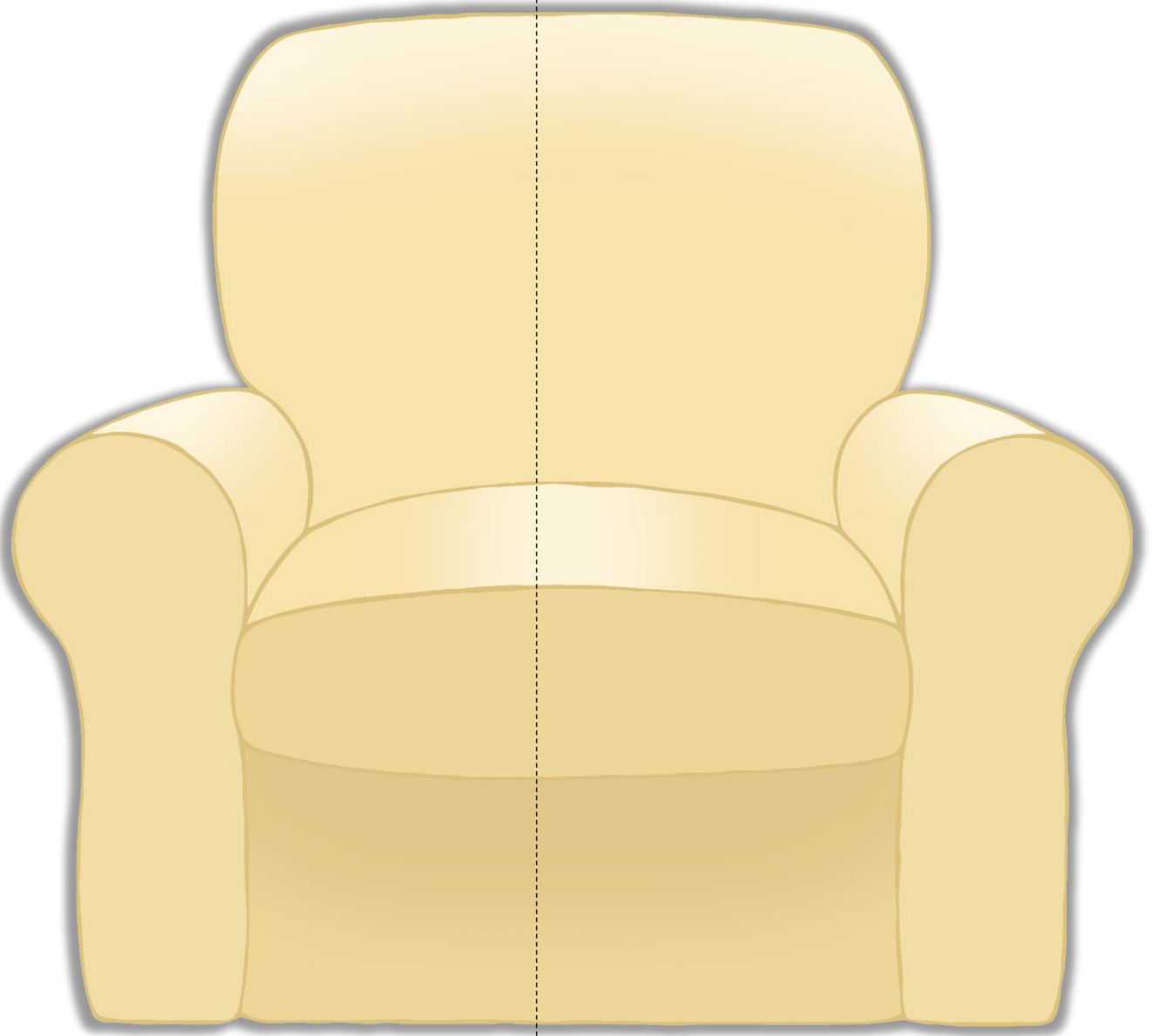

**ch**  

---

**air**  

---

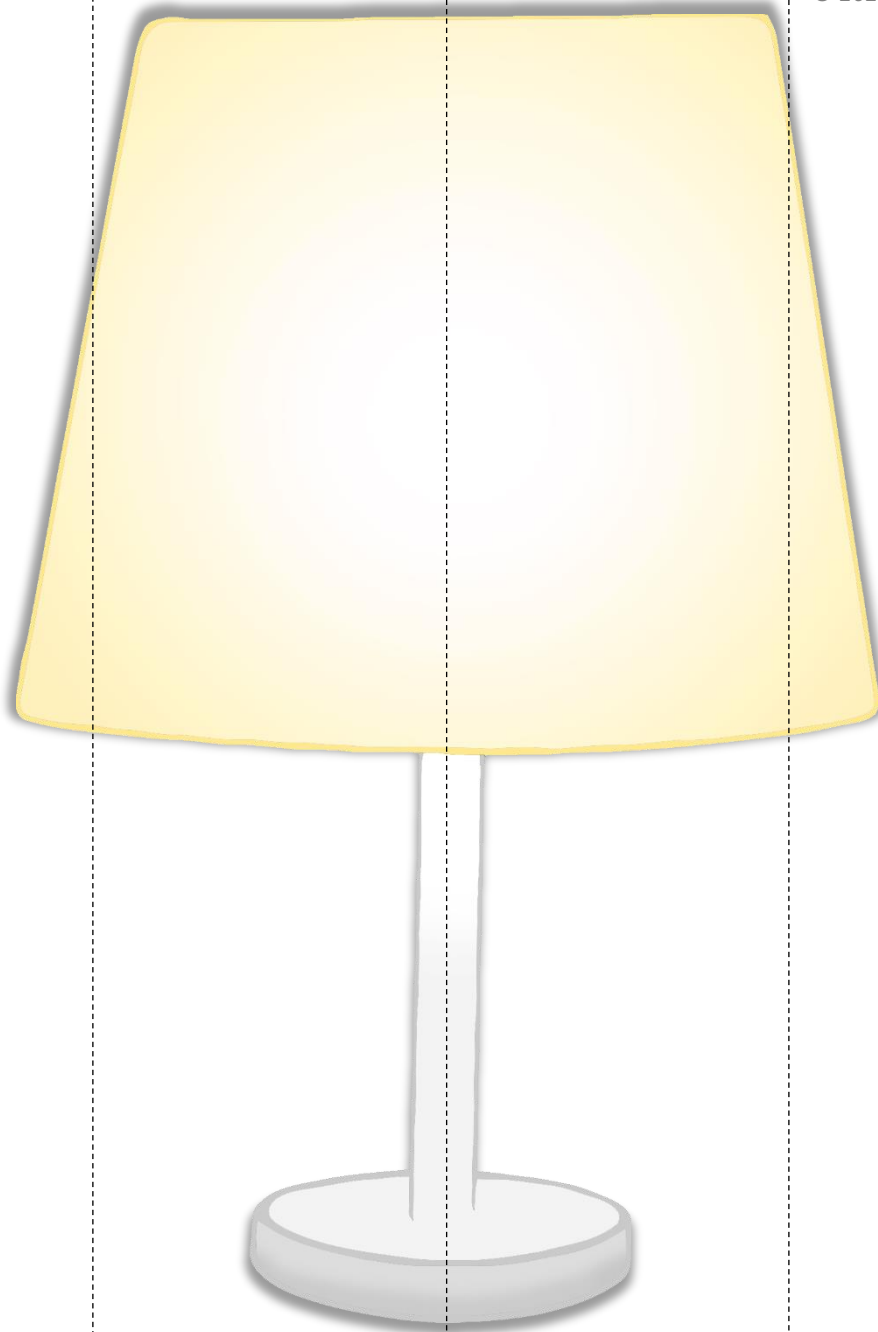

l



a



m



p



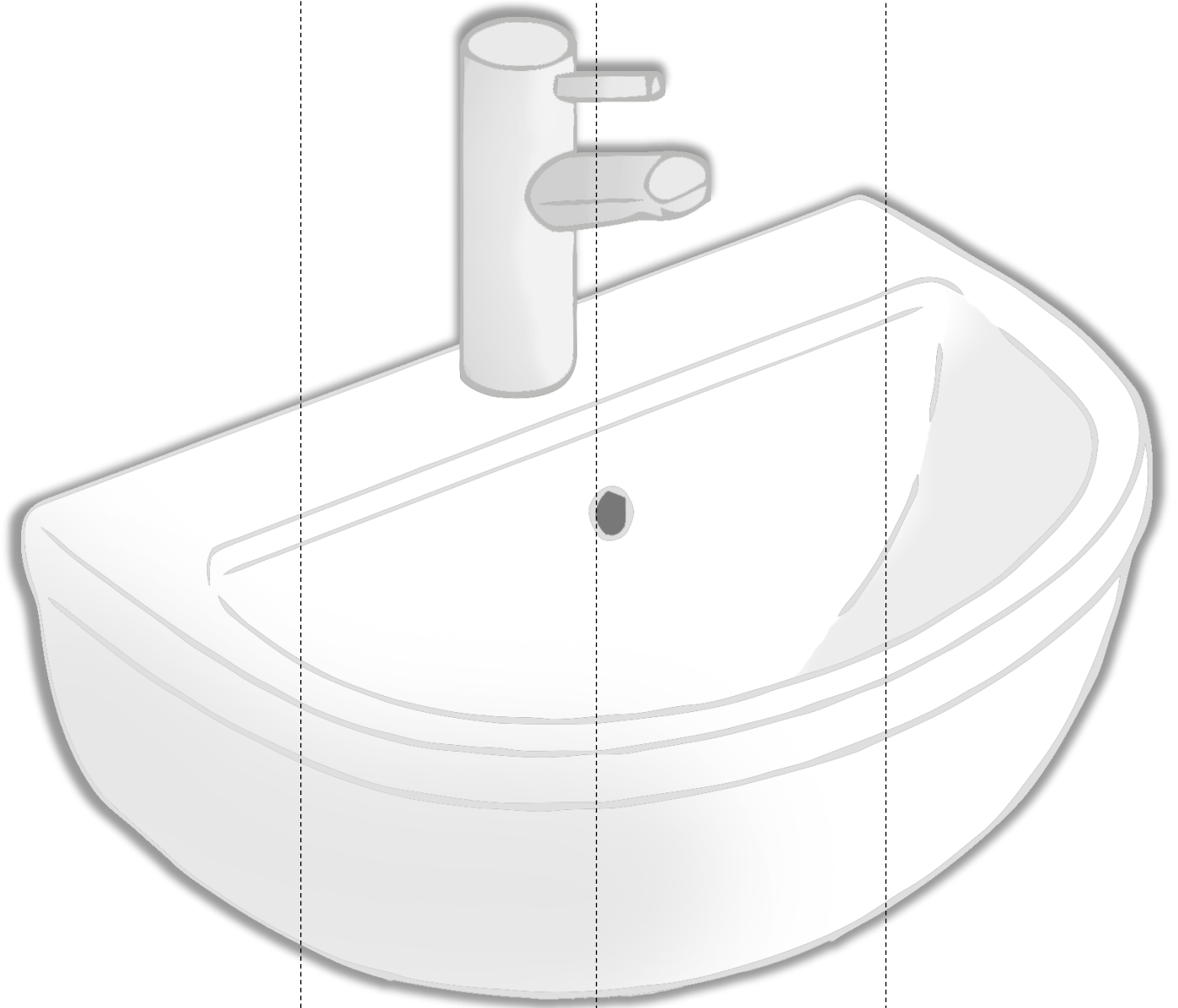

s

•

i

•

n

•

k

•

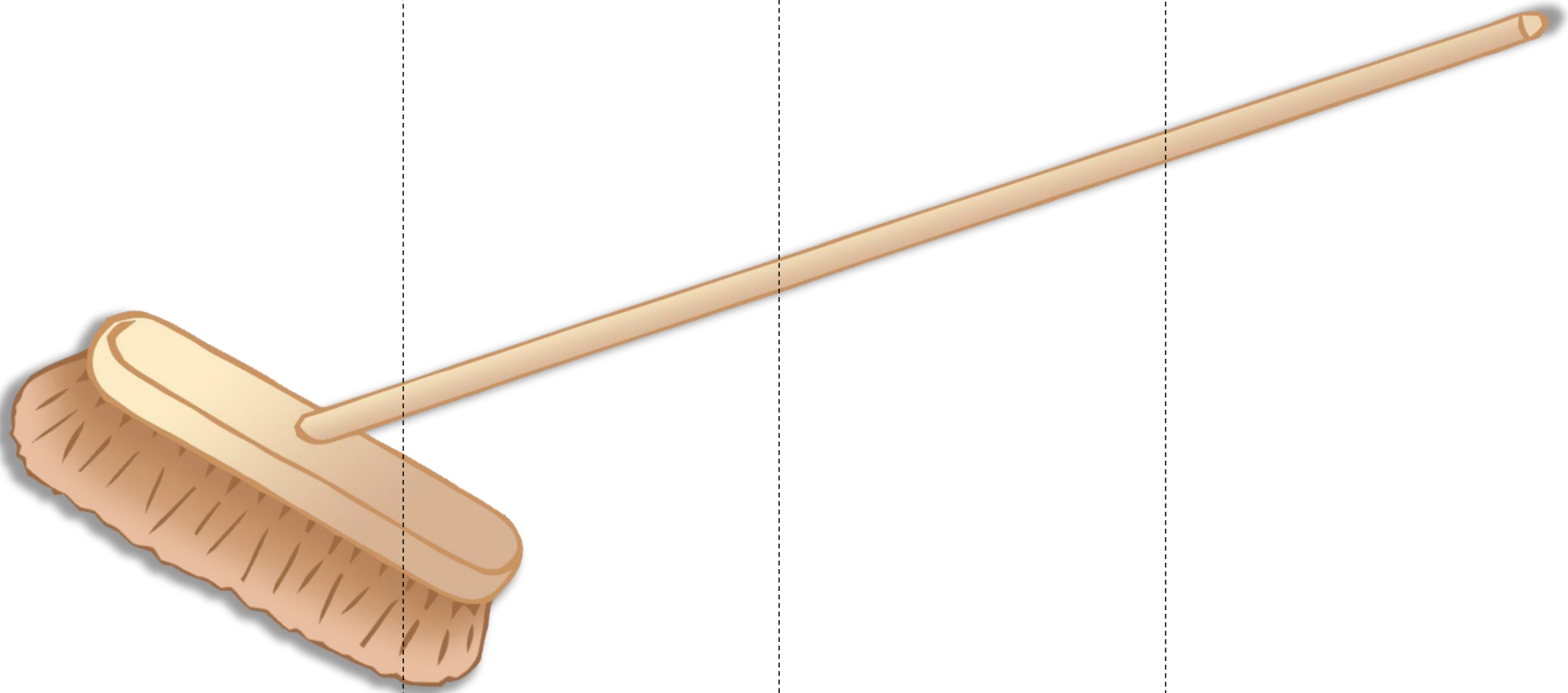

b  
.

r  
.

oo

m  
.

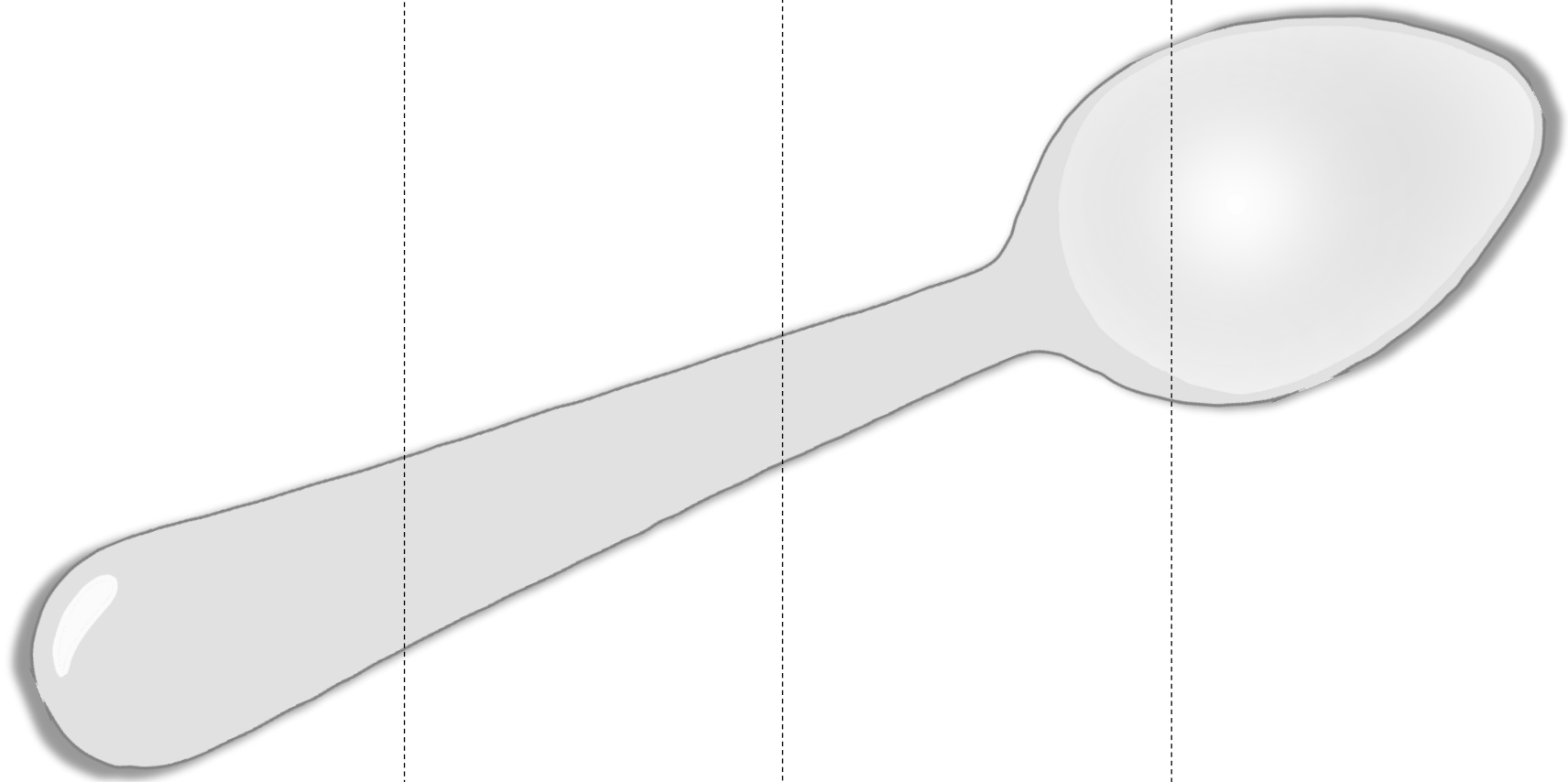

**s**  
.

**p**  
.

**oo**  
—

**n**  
.