

# People Who Help Us

## Caretaker

The pages of this pack give some general information about the role of a caretaker and some fun and engaging activities to foster and develop children's interest in this role in society.

### This pack includes:

- Information Posters
- Information Posters (Colouring)
- Drawing/Writing Sheets
- Draw items Sheet
- Draw items Sheet (Colouring)
- Item Poster
- Item Poster (Colouring)
- Multimats for Art & Craft/Loose Parts/Playdough
- 5x 2-Piece individual items puzzles
- 1x 4-Piece all items puzzle

# Caretaker

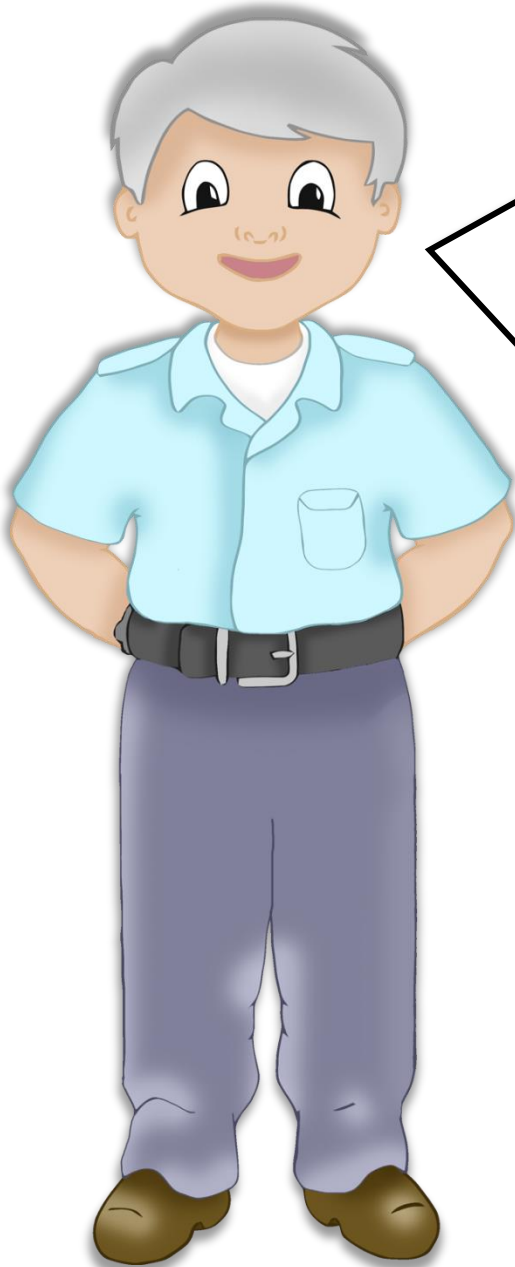

**I'm a caretaker.**  
I work at a school. I fix things that get broken or are not working properly. It is my job to make sure the school grounds are safe and ready for the children and teachers to enjoy their day!

I have a big set of tools ready for anything that might need fixing!



# Caretaker

If there is a dangerous spillage, I am ready with my mop!



I use a broom to sweep up anything that might be dangerous.



I am in charge of locking and unlocking the school with my keys.



# Caretaker



I'm a caretaker.  
I work at a school. I  
fix things that get  
broken or are not  
working properly.  
It is my job to make  
sure the school  
grounds are safe and  
ready for the  
children and teachers  
to enjoy their day!

I have a big set of  
tools ready for  
anything that  
might need fixing!

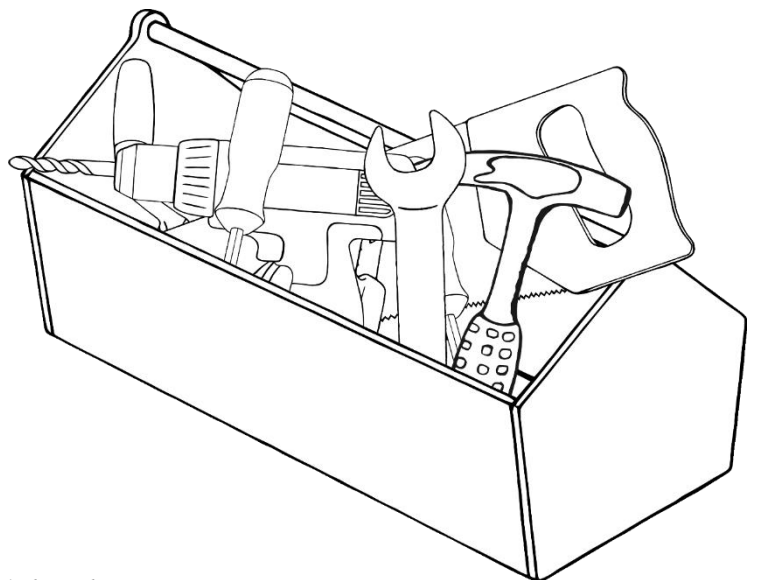

# Caretaker

If there is a dangerous spillage, I am ready with my mop!

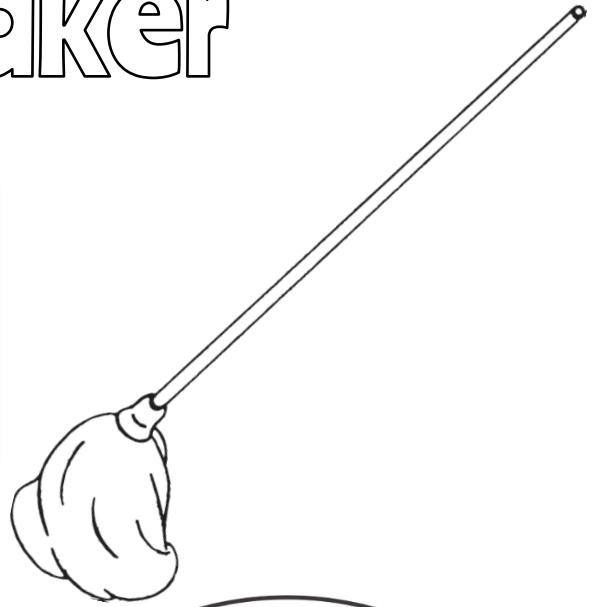

I use a broom to sweep up anything that might be dangerous.

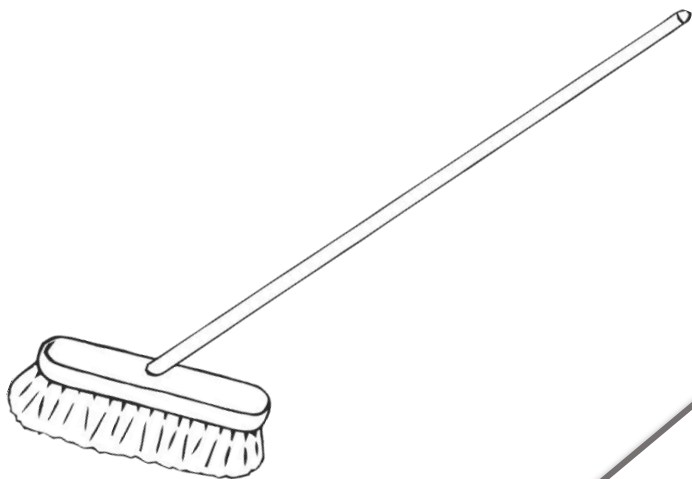
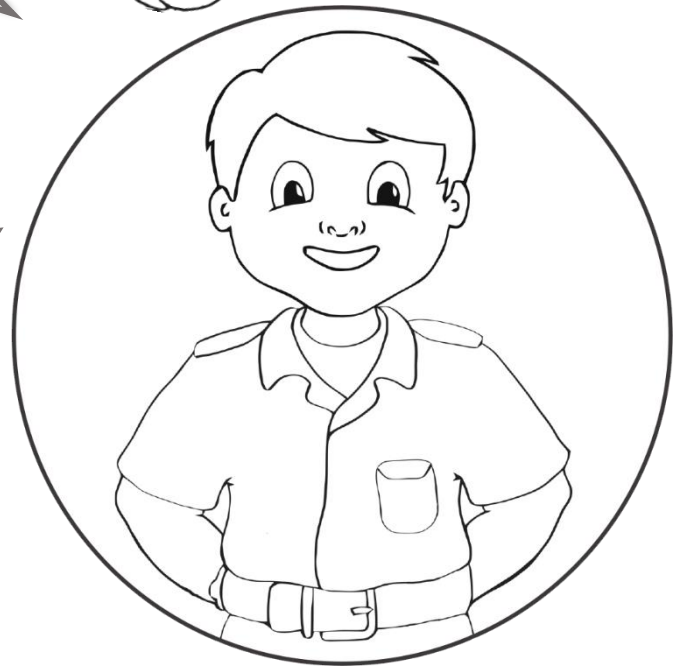

I am in charge of locking and unlocking the school with my keys.



# Draw a Caretaker!



A large, empty rectangular area with rounded corners, outlined in black, intended for drawing a caretaker.

# Draw and write about a Caretaker!



A large rectangular area with rounded corners, outlined in black, intended for drawing and writing. At the bottom of this area, there are three horizontal grey lines spaced vertically, providing a guide for writing.

Draw and write about a

Caretaker!



---

---

---

---

---

---

---

---



Can you draw the items a caretaker needs?



Can you draw the items a caretaker needs?



# Caretaker



keys

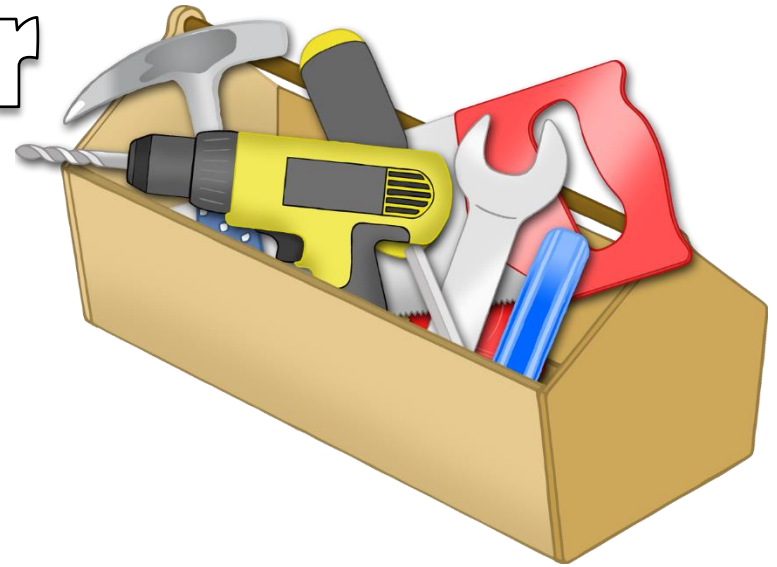

toolbox



broom

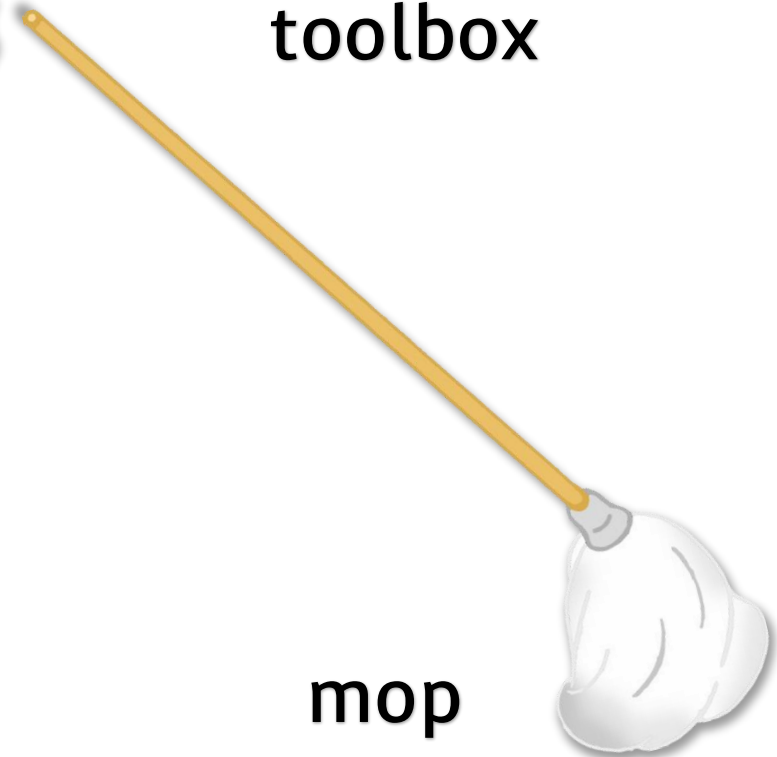

mop

# Caretaker



keys

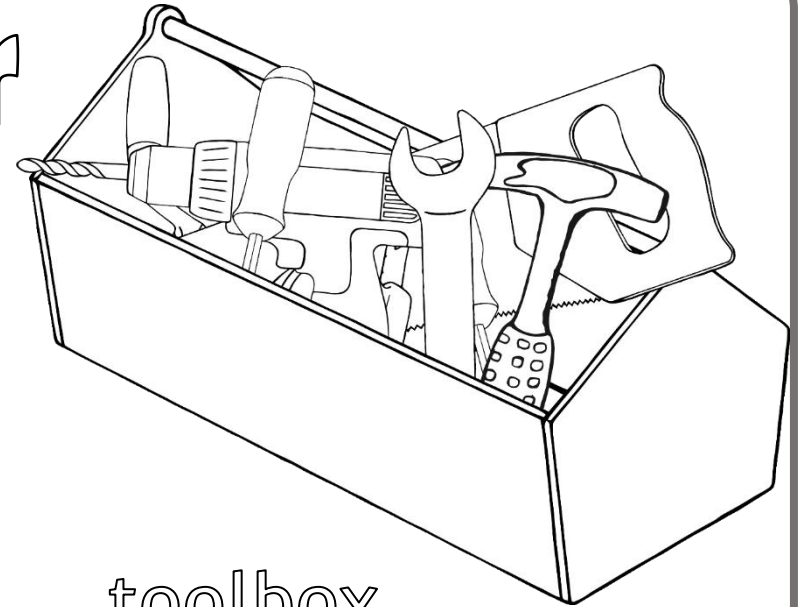

toolbox

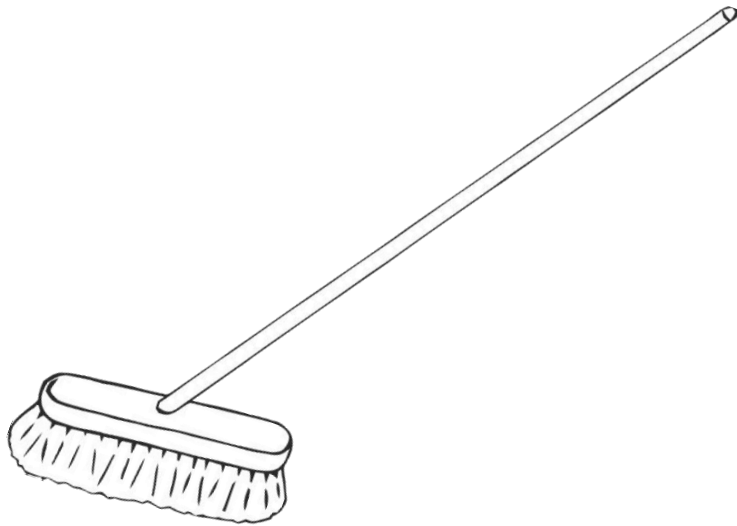
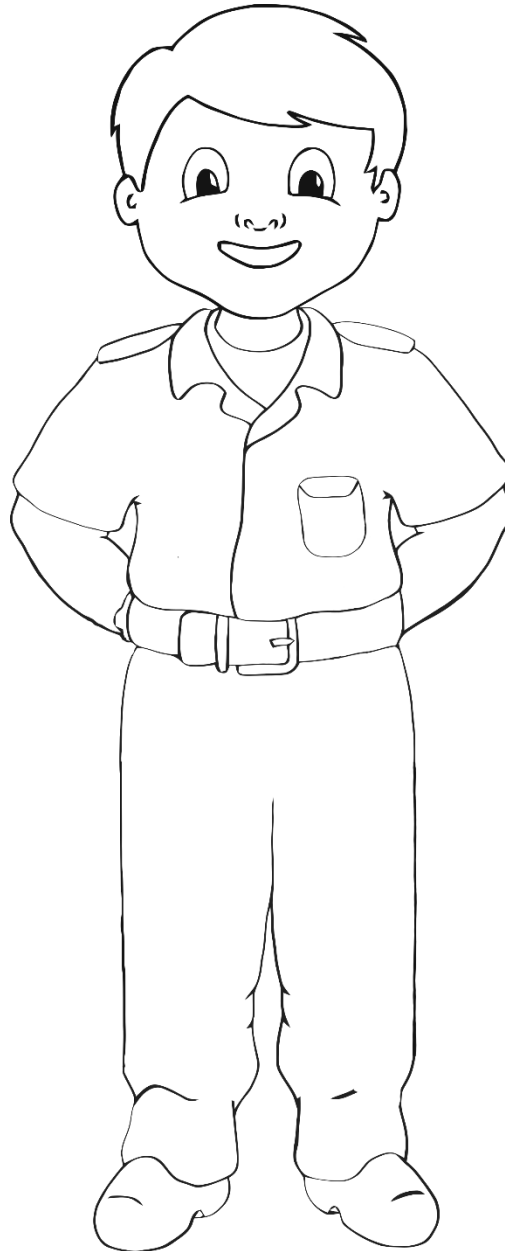

broom

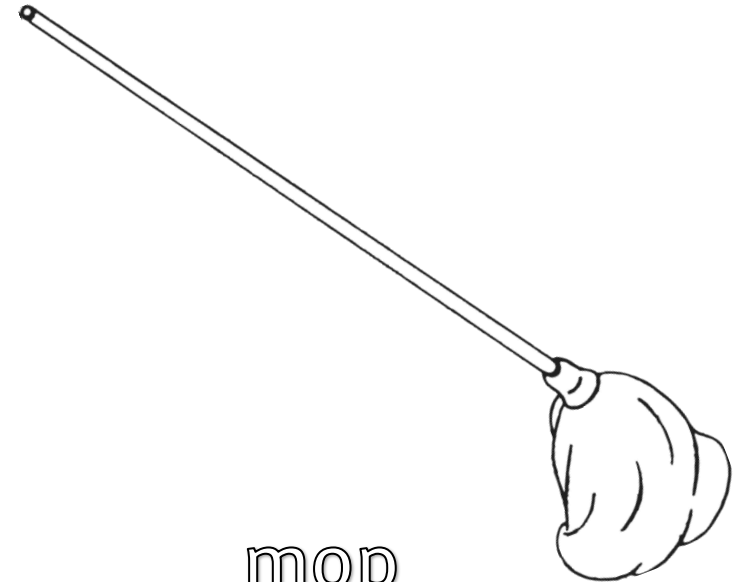

mop

# Caretaker Multimat - toolbox

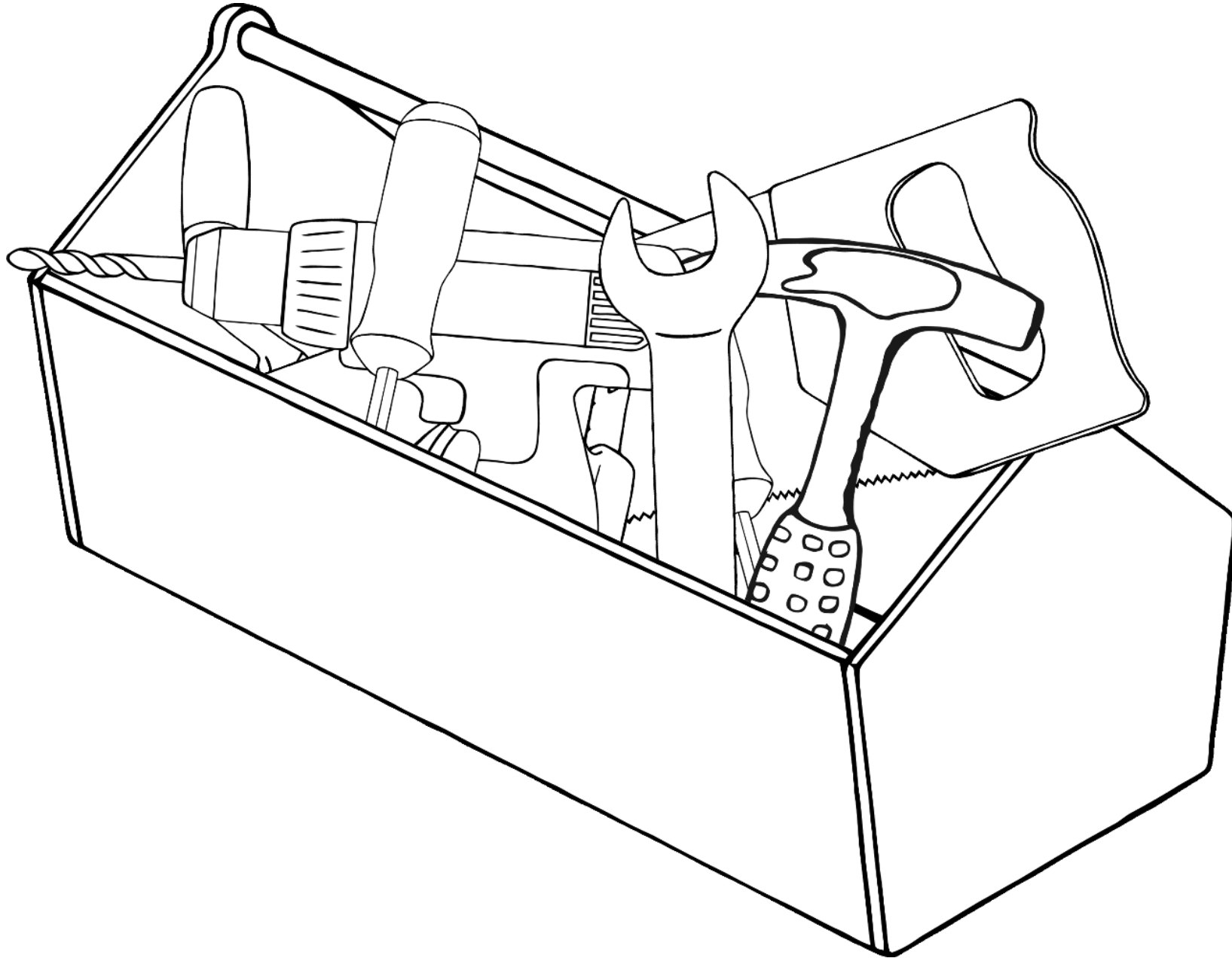
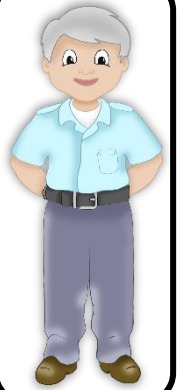

# Caretaker Multimat – broom and mop

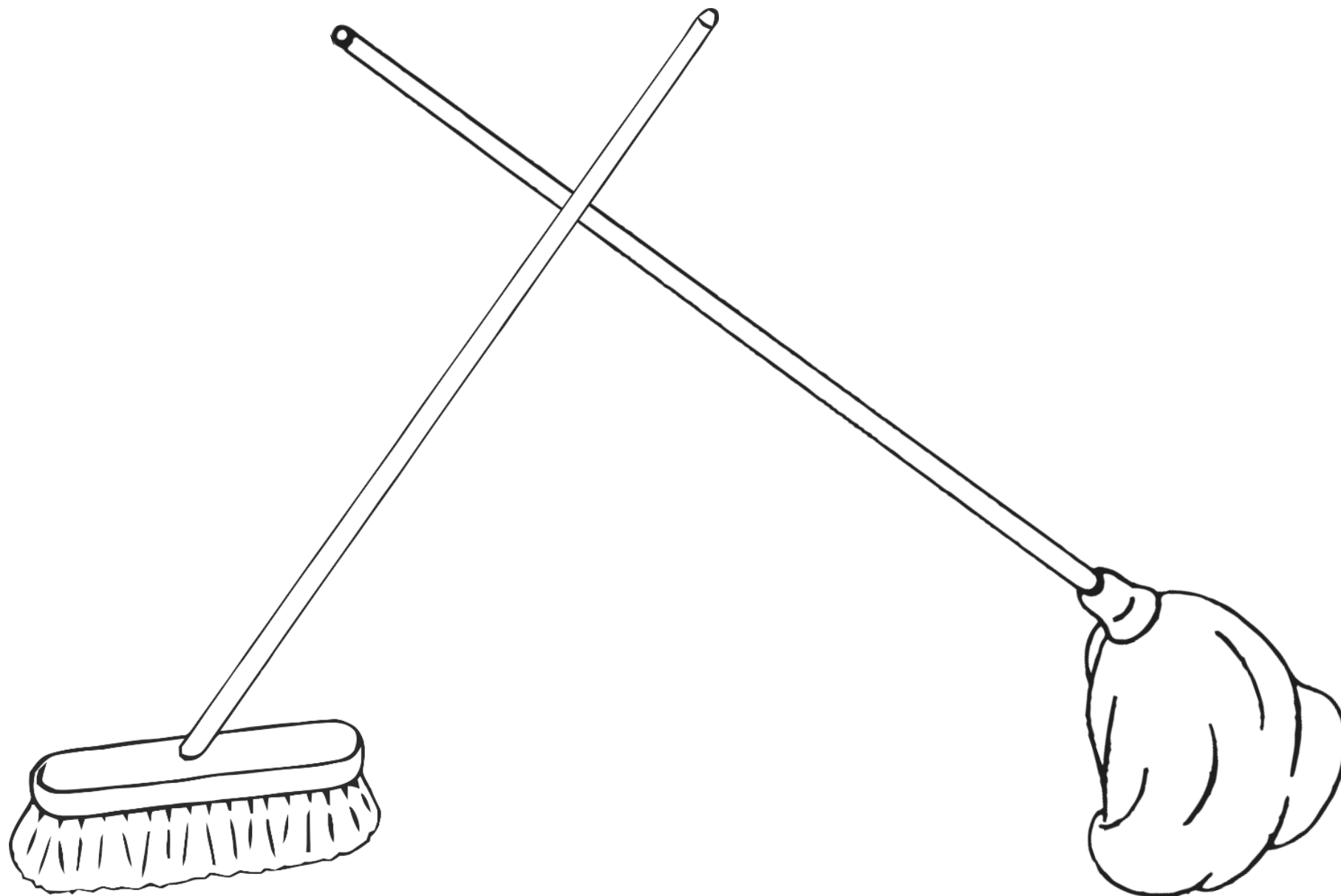
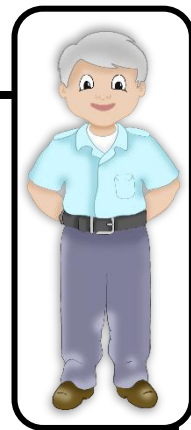

# Caretaker Multimat - keys

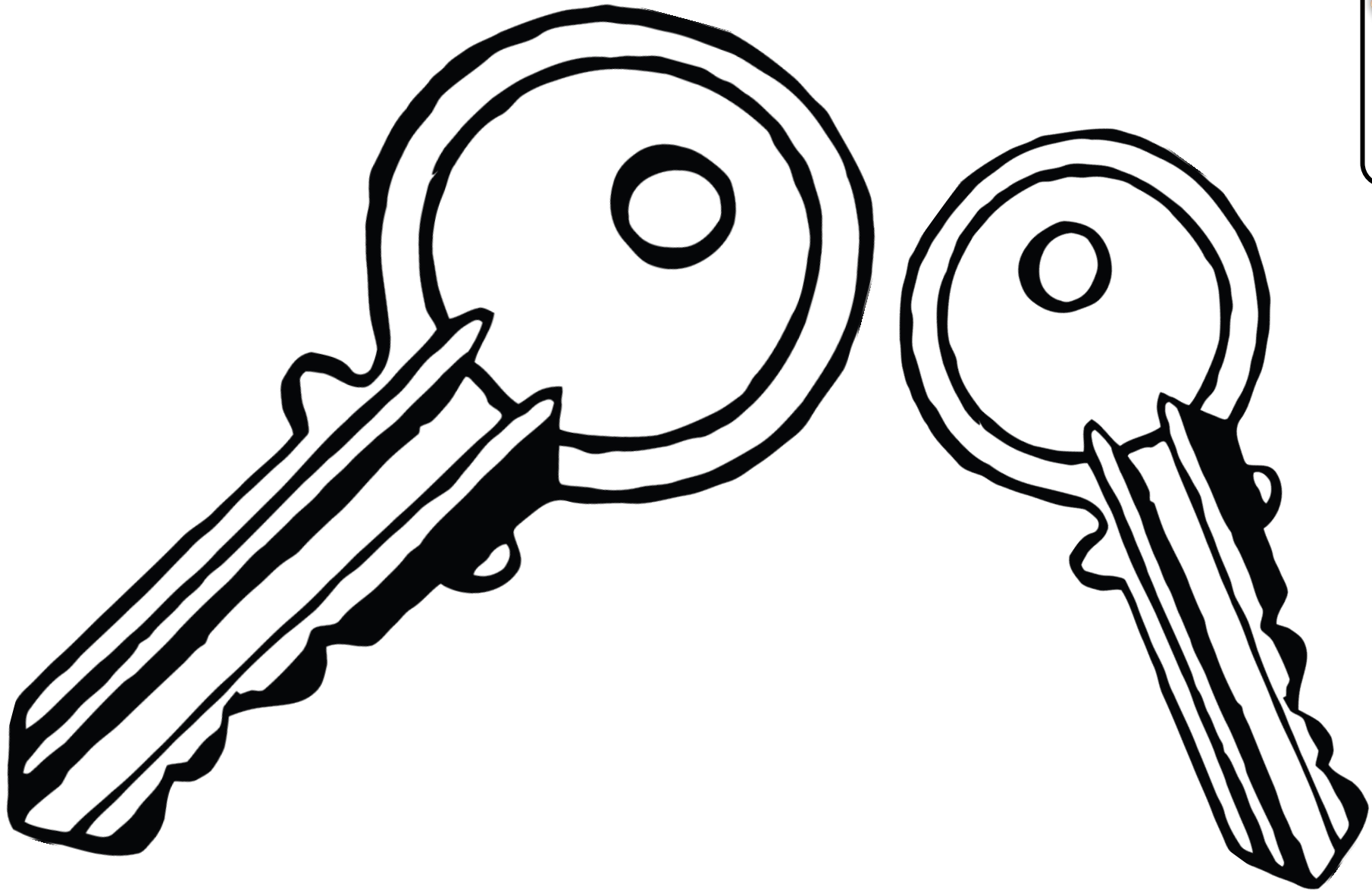
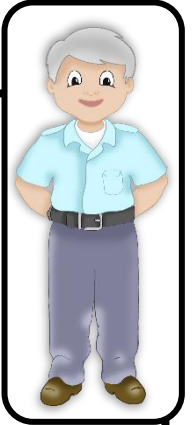

# Caretaker Multimat - tools

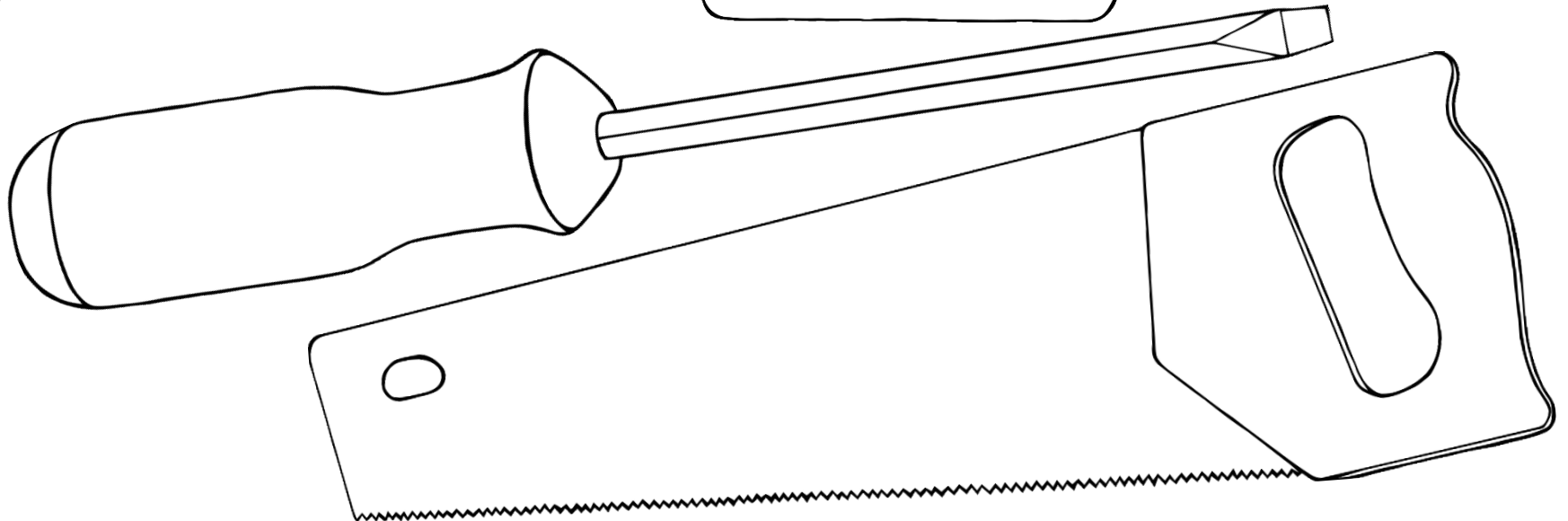
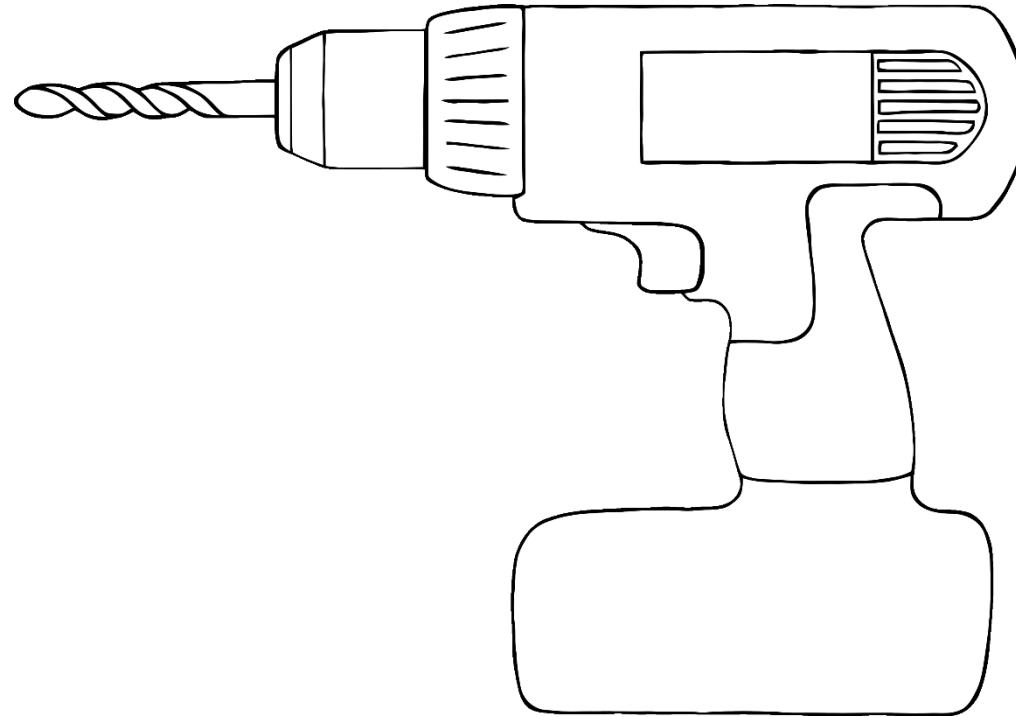
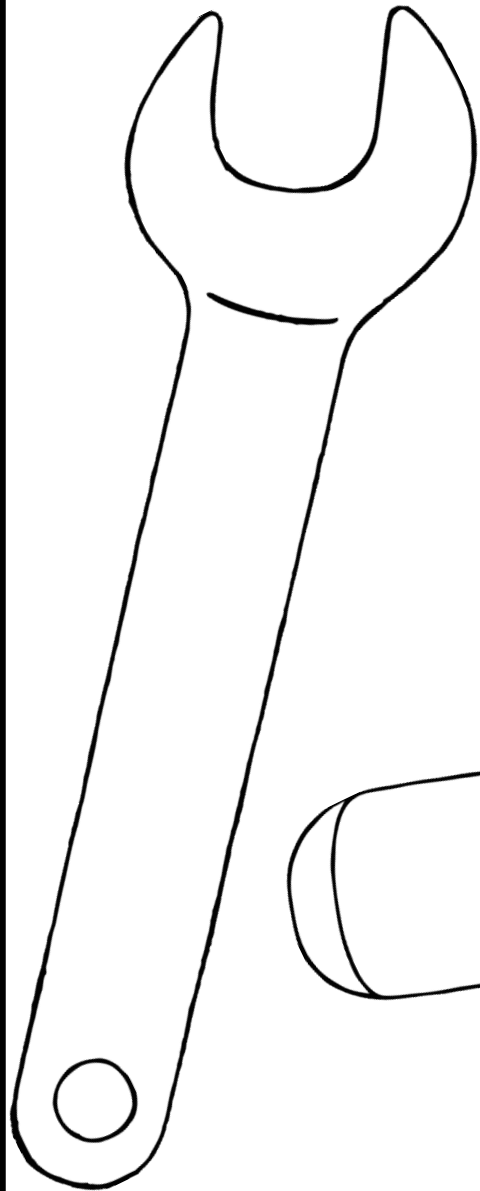
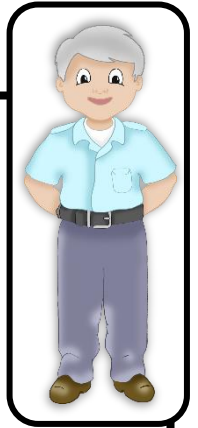



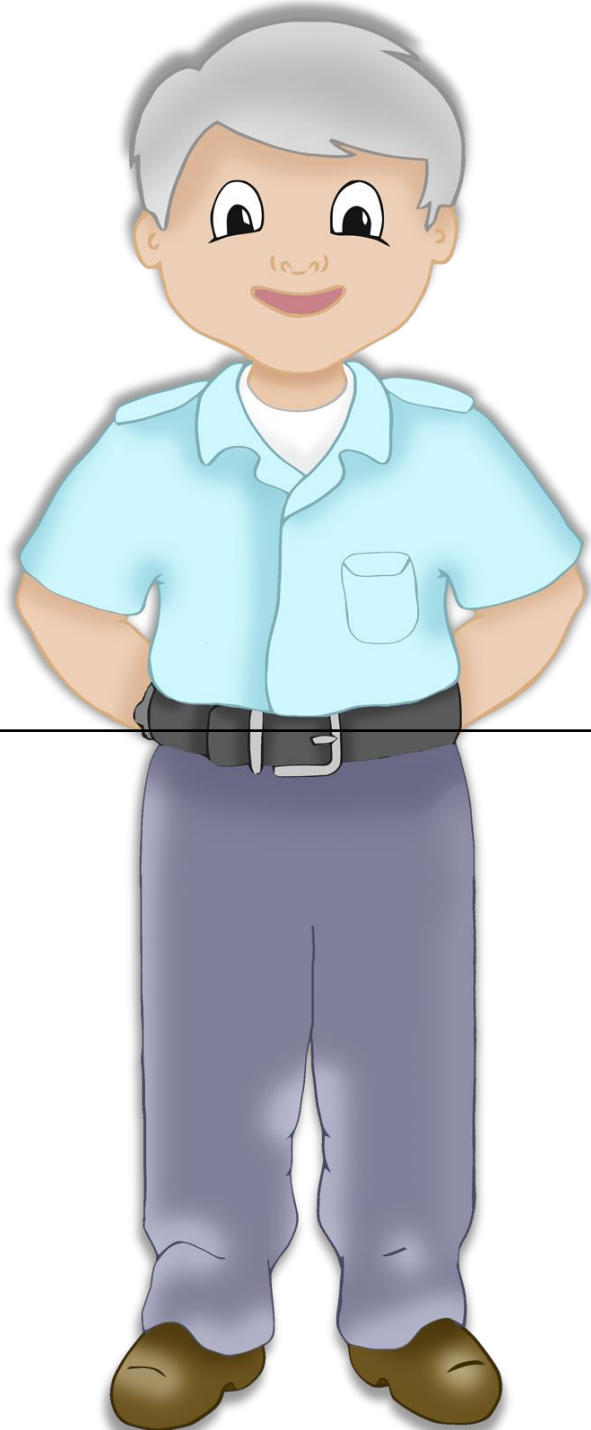

© 2023 Little Owls Resources

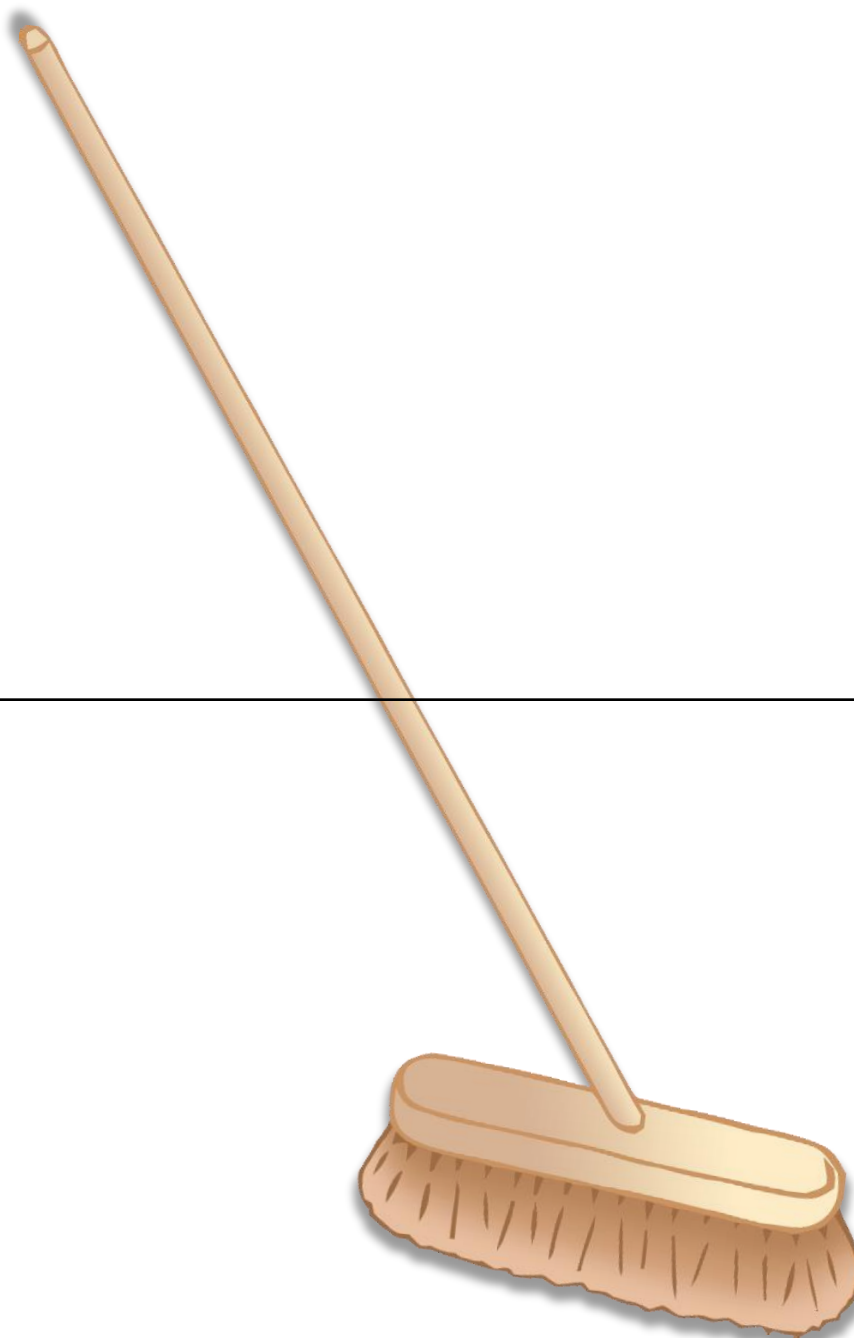

© 2023 Little Owls Resources

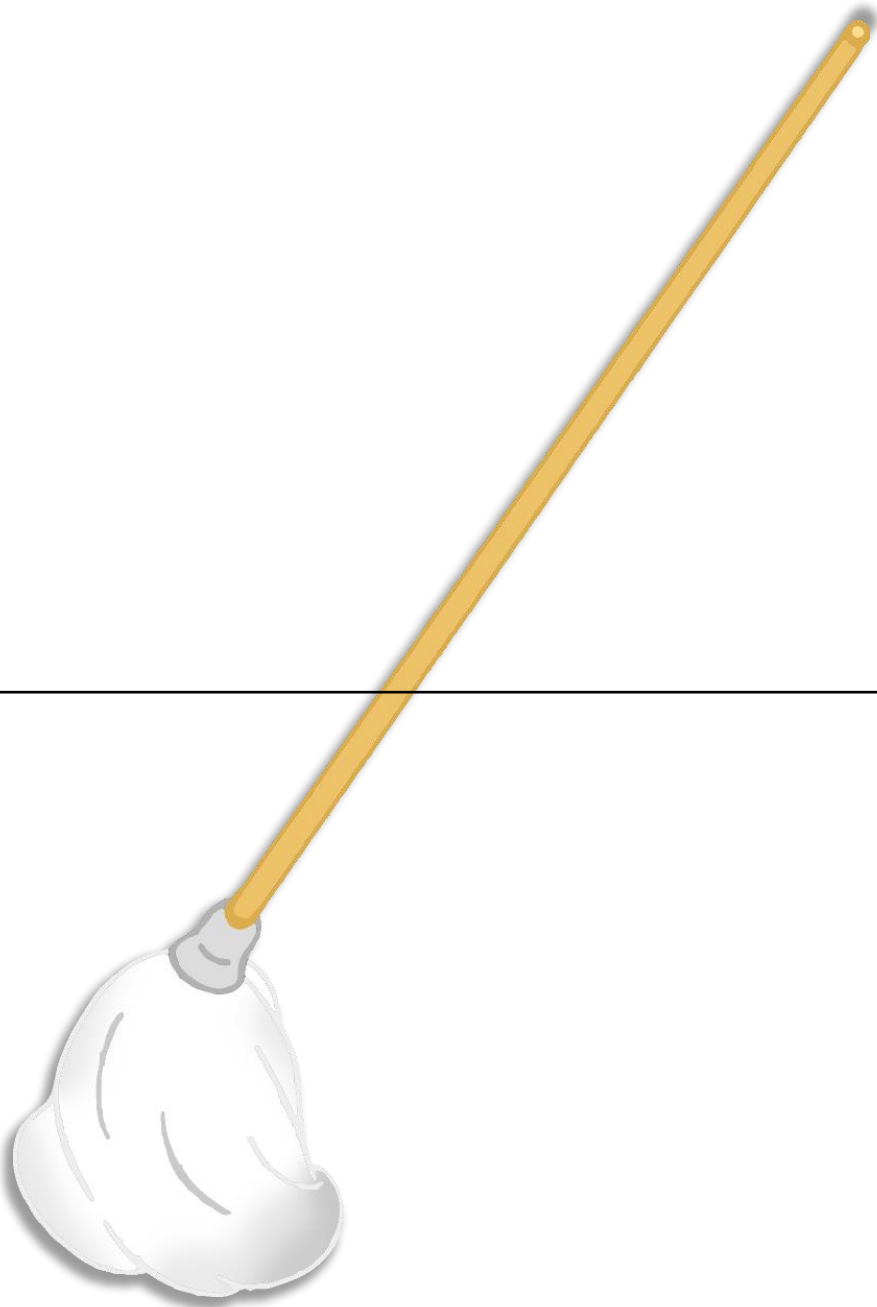

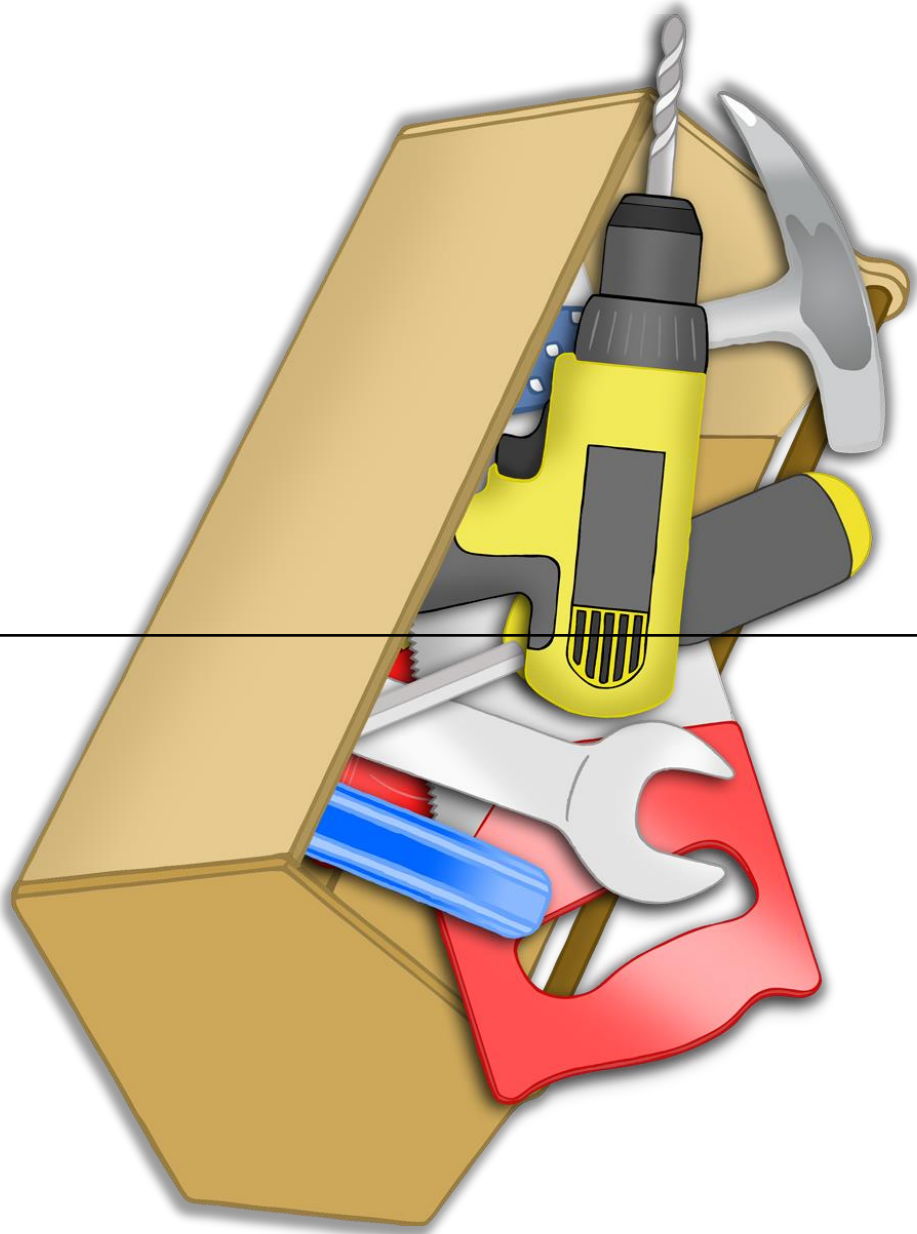

# Caretaker



keys



tools

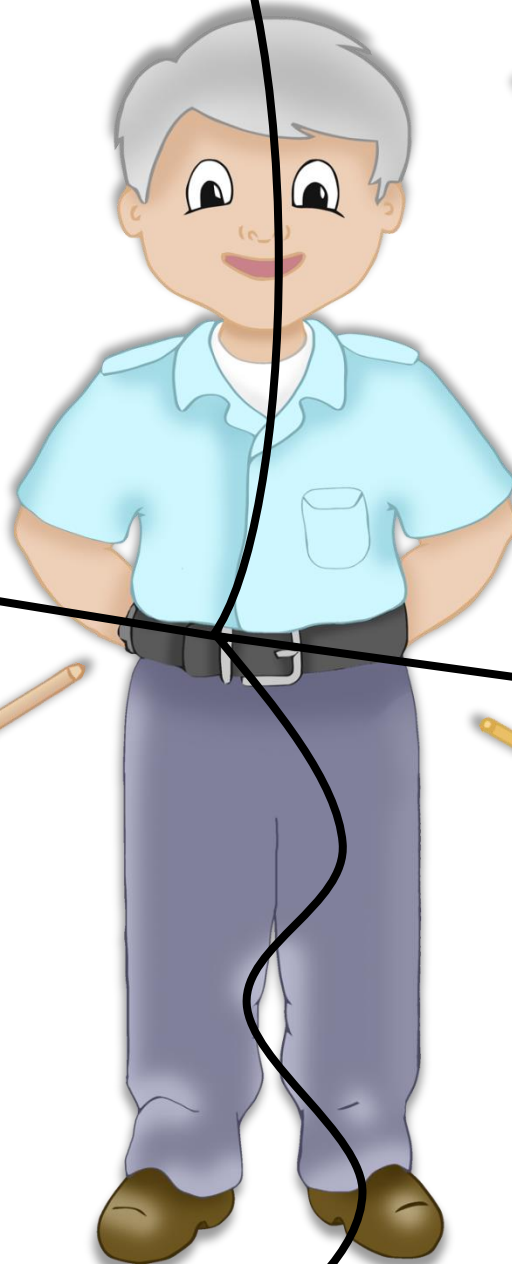

broom



mop