

# People Who Help Us

# Optometrist

The pages of this pack give some general information about the role of a optometrist and some fun and engaging activities to foster and develop children's interest in this role in society.

**This pack includes:**

- Information Posters
- Information Posters (Colouring)
- Drawing/Writing Sheets
- Draw items Sheet
- Draw items Sheet (Colouring)
- Item Poster
- Item Poster (Colouring)
- Multimats for Art & Craft/Loose Parts/Playdough
- 5x 2-Piece individual items puzzles
- 1x 4-Piece all items puzzle

# Optometrist



I'm an **optometrist**.  
I check whether  
someone needs  
glasses by asking  
them to read letters  
on a chart.

I check which glasses  
will help them see  
clearly and then they  
choose the style they  
like.

I use an  
ophthalmoscope to  
look closely into a  
person's eyes to see if  
they are healthy.

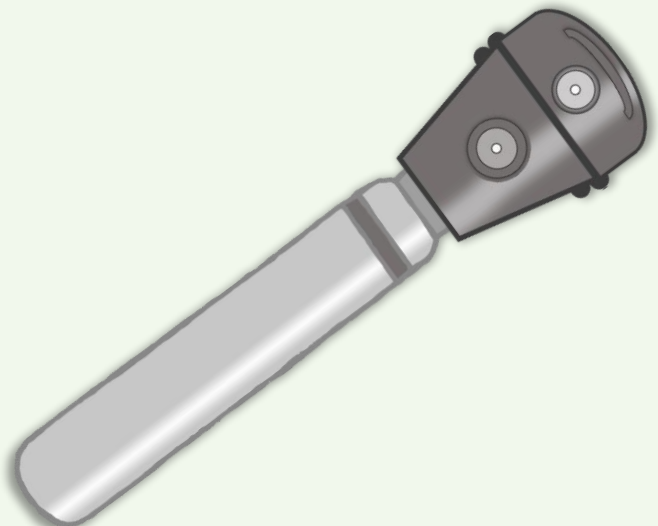

# Optometrist

If someone has tired or itchy eyes, I might give them eye drops.



The eye chart has letters on that get smaller and smaller.

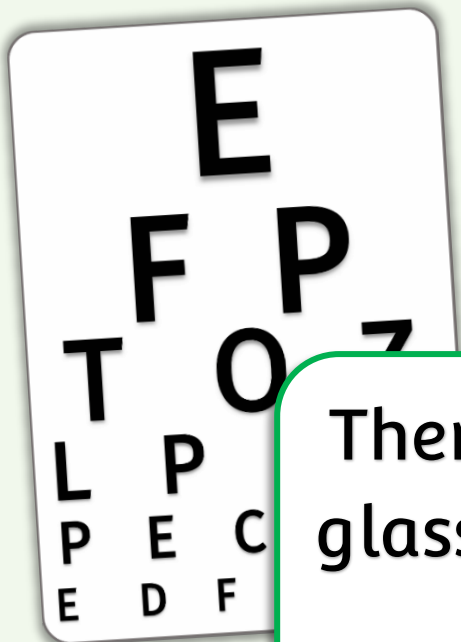

There are lots of glasses to choose from.



# Optometrist

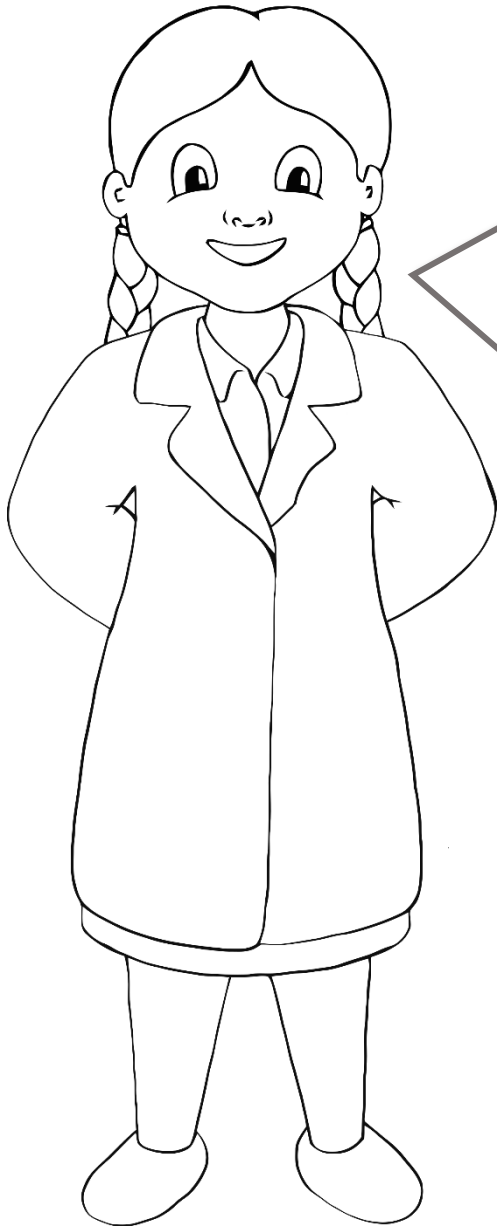

I'm an optometrist.  
I check whether  
someone needs  
glasses by asking  
them to read letters  
on a chart.

I check which glasses  
will help them see  
clearly and then they  
choose the style they  
like.

I use an  
ophthalmoscope to  
look closely into a  
person's eyes to see if  
they are healthy.

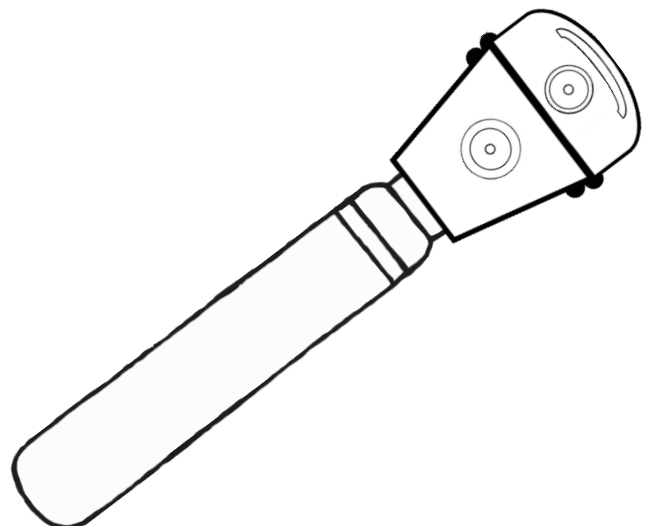

# Optometrist

If someone has tired  
or itchy eyes, I  
might give them eye  
drops.

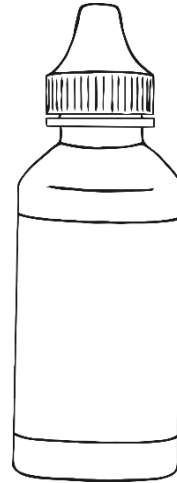

The eye chart has  
letters on that get  
smaller and  
smaller.

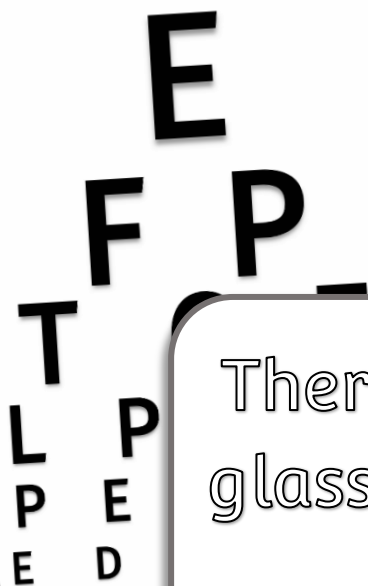

There are lots of  
glasses to choose  
from.

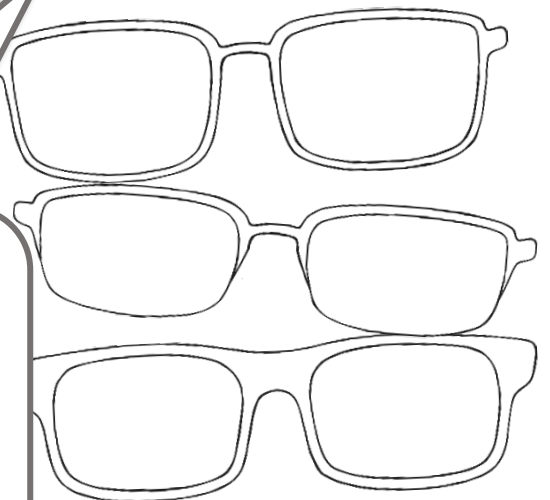

# Draw an Optometrist!



A large, empty rectangular area with rounded corners, outlined in green, intended for drawing an optometrist.

# Draw and write about an Optometrist!



A large, empty rectangular box with rounded corners, outlined in green, intended for drawing and writing. At the bottom of this box, there are three horizontal grey lines spaced vertically, providing a guide for writing.

# Draw and write about an Optometrist!



---

---

---

---

---

---

---

---



Can you draw the items an optometrist needs?



Can you draw the items an optometrist needs?

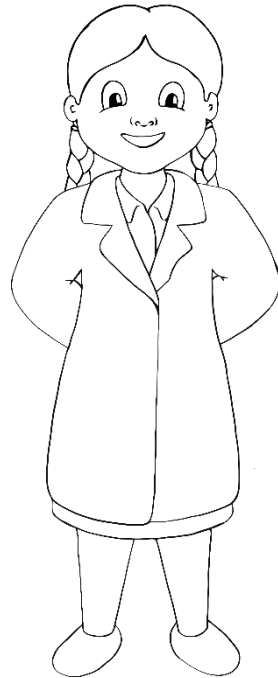

# Optometrist



eye drops

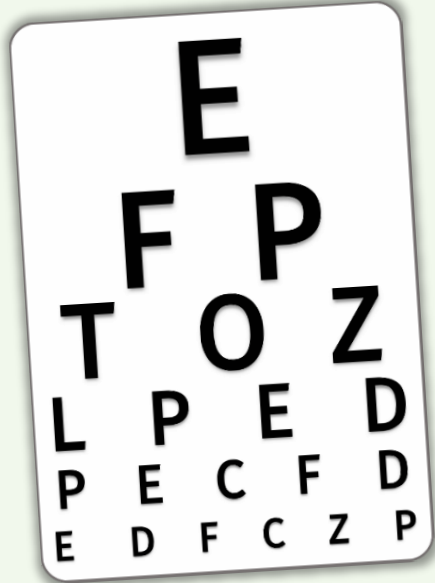

eye chart

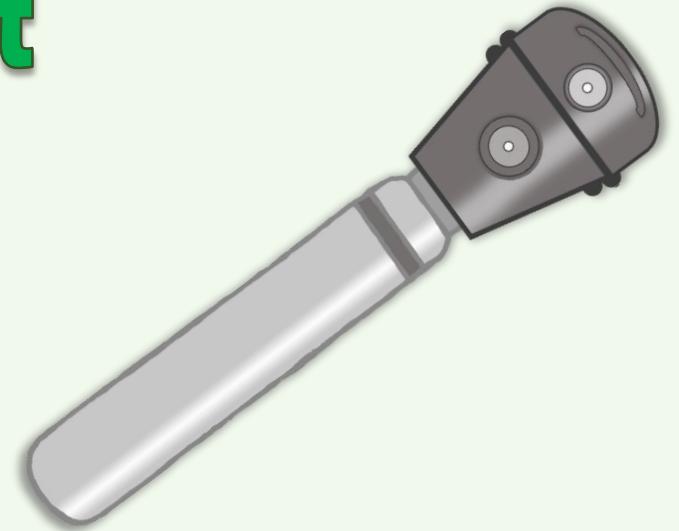

ophthalmoscope

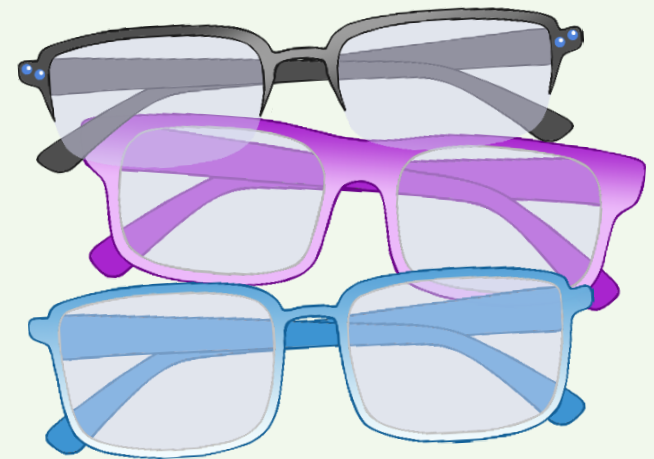

glasses

# Optometrist



eye drops

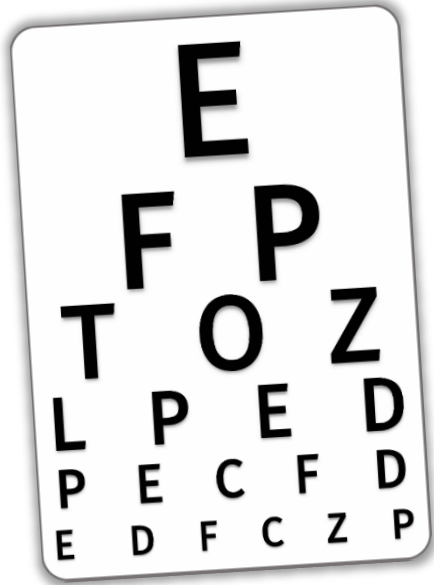

eye chart

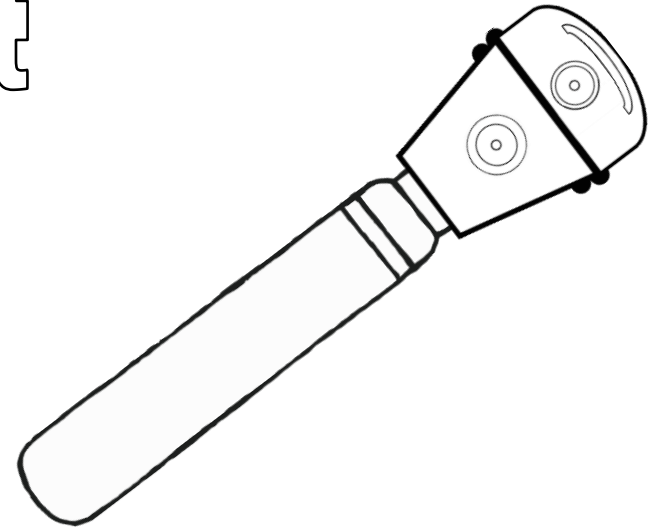
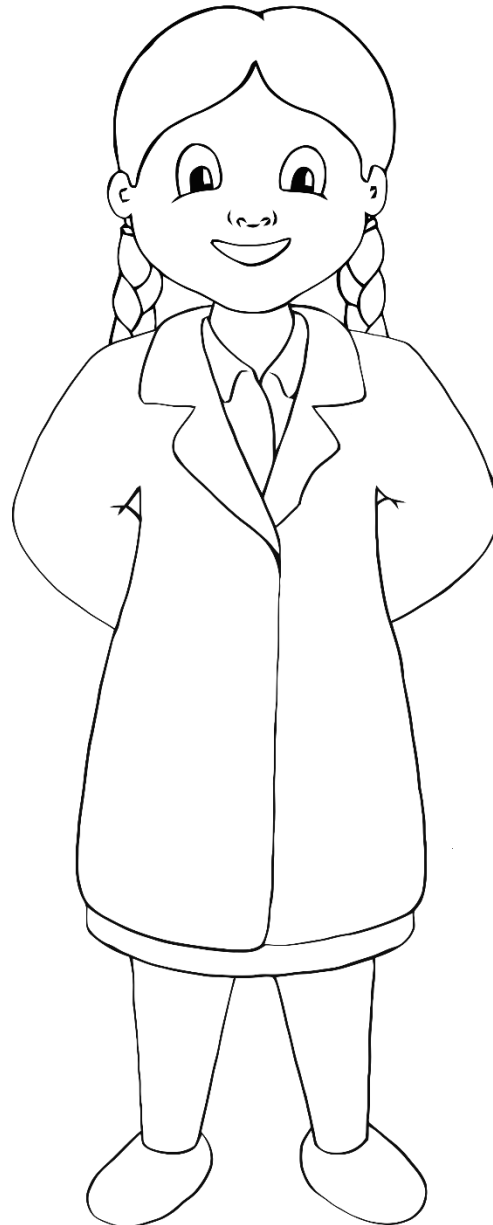

ophthalmoscope

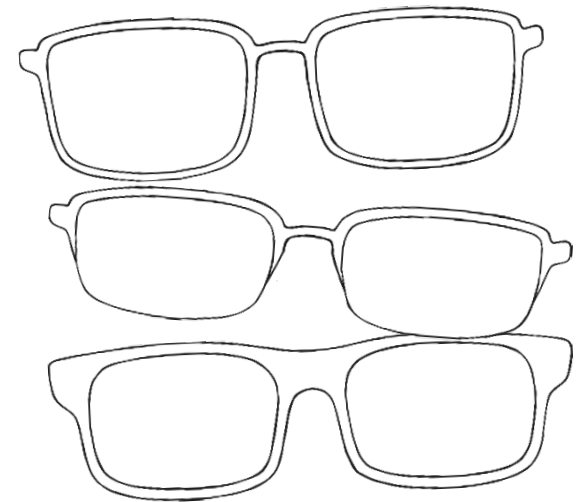

glasses

# Optometrist Multimat – Eye drops



# Optometrist Multimat – Ophthalmoscope

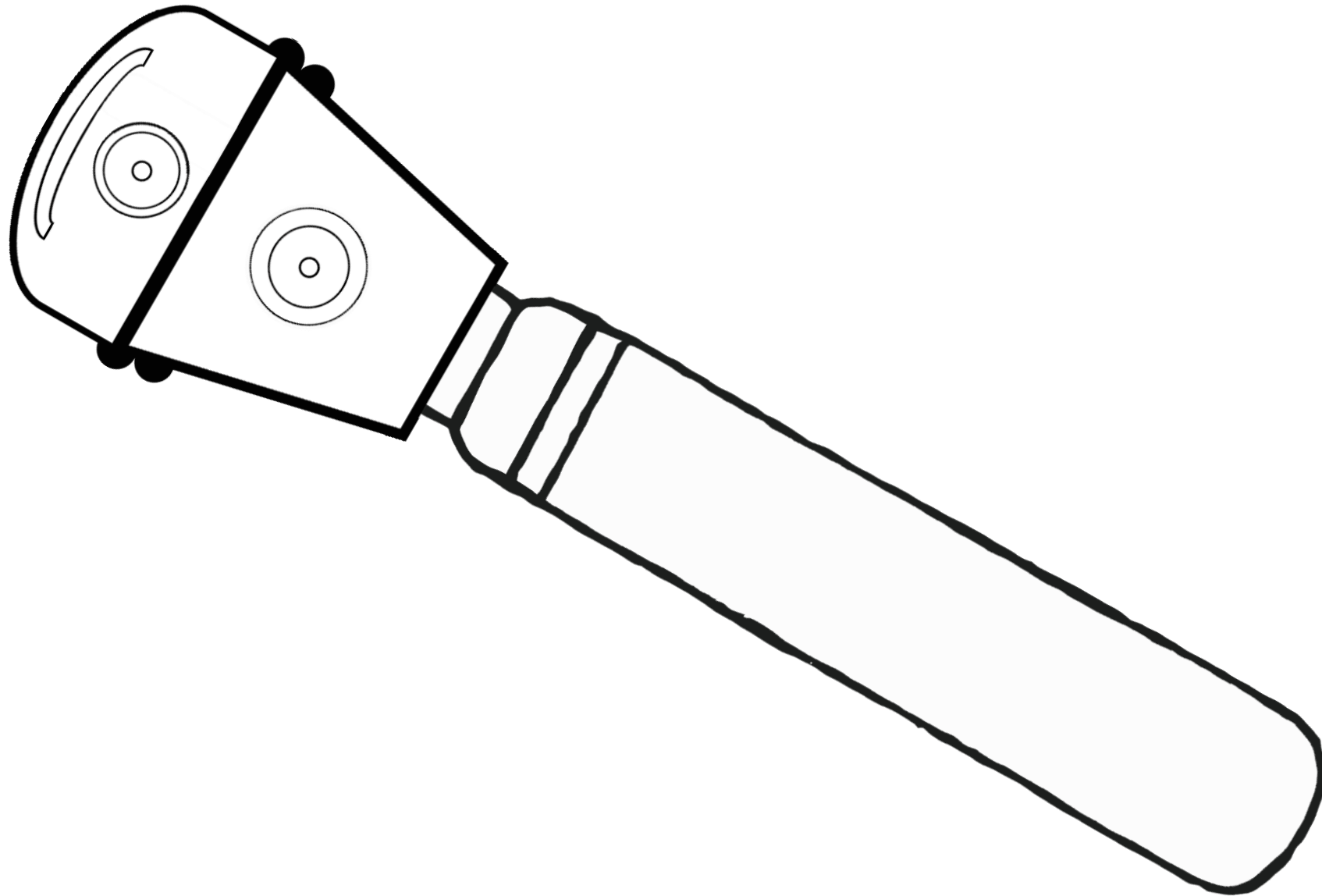

# Optometrist Multimat – Glasses (1)

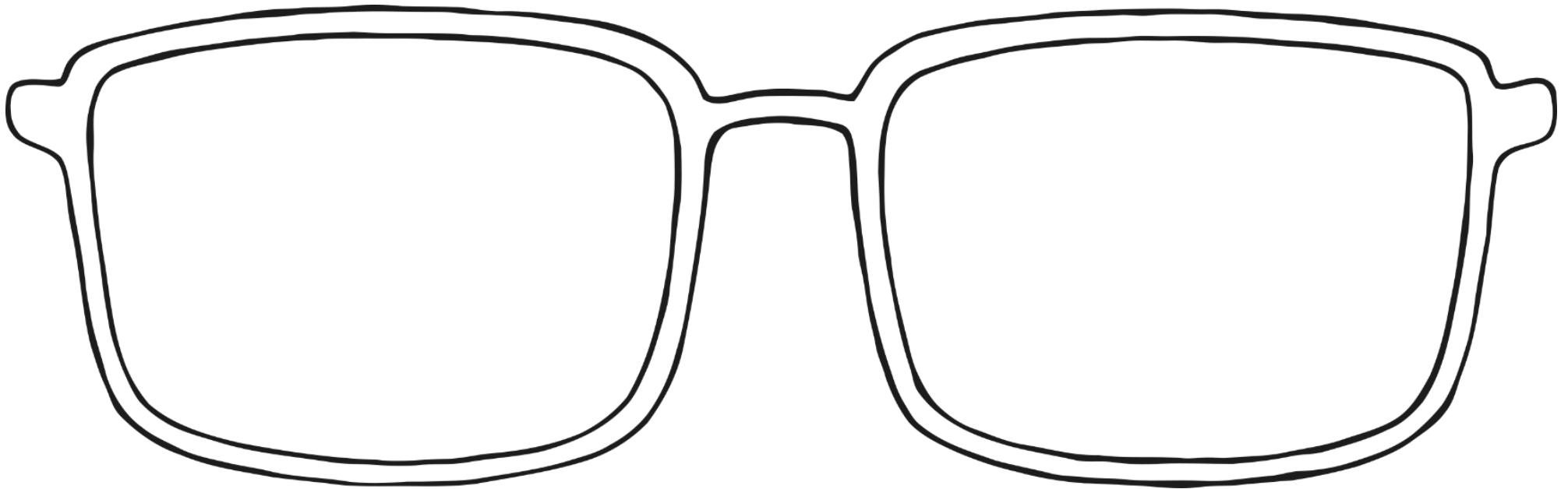

# Optometrist Multimat – Glasses (2)

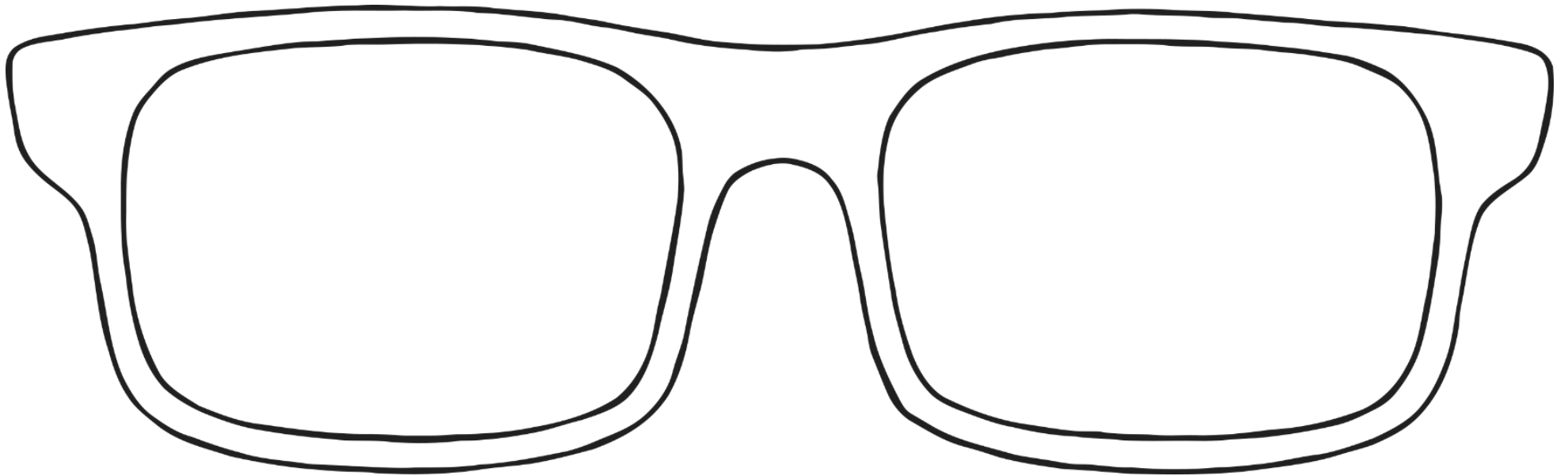



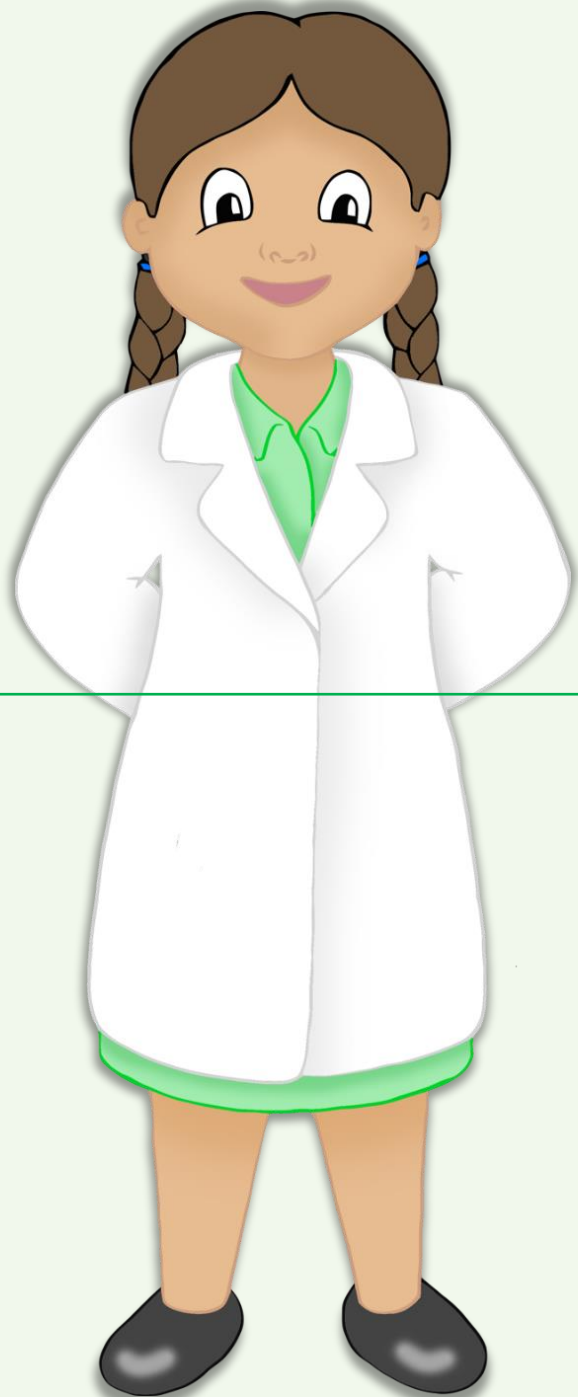

© 2023 Little Owls Resources

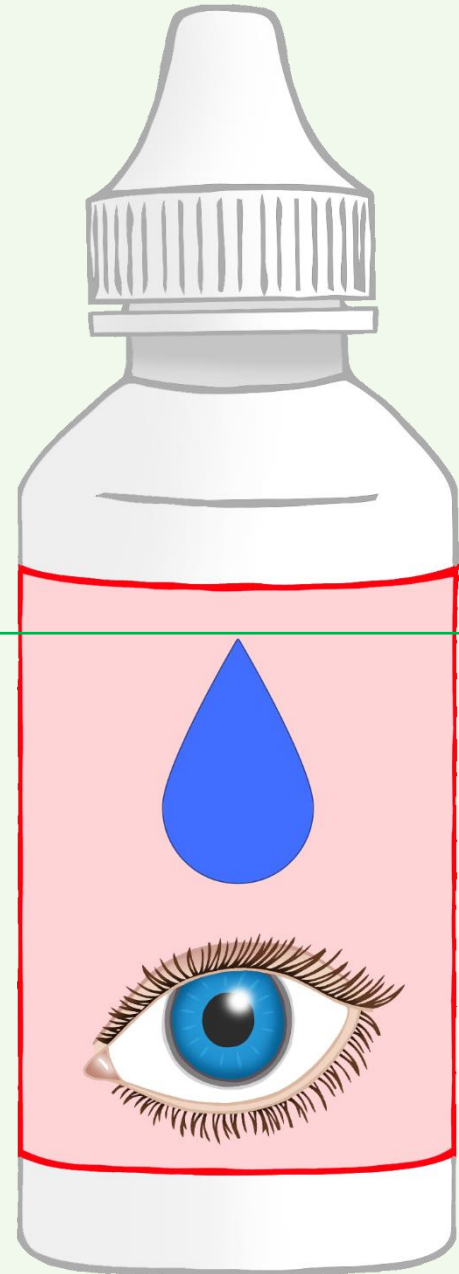

© 2023 Little Owls Resources

E

F P

T O Z

L P E D

P E C F D

E D F C Z P

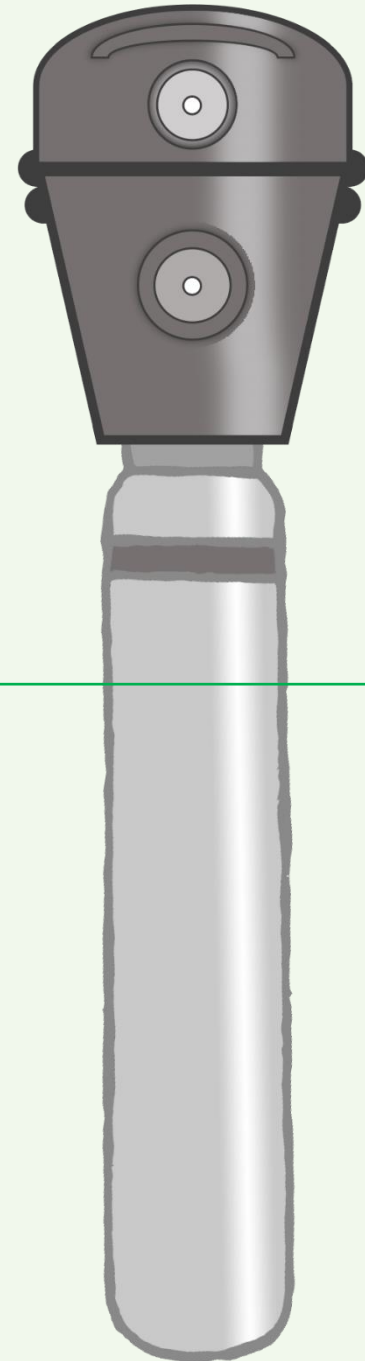

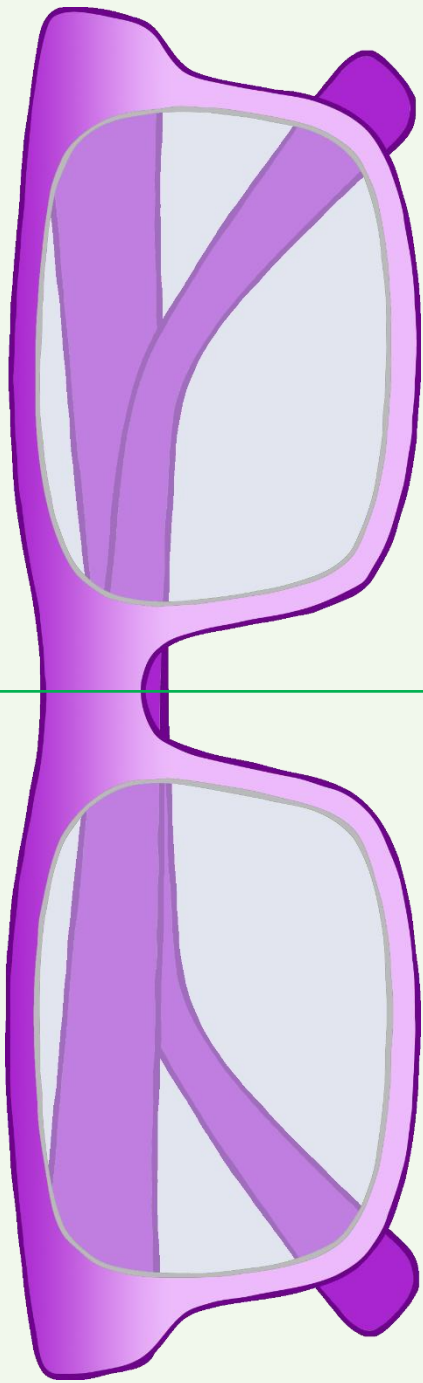

© 2023 Little Owls Resources

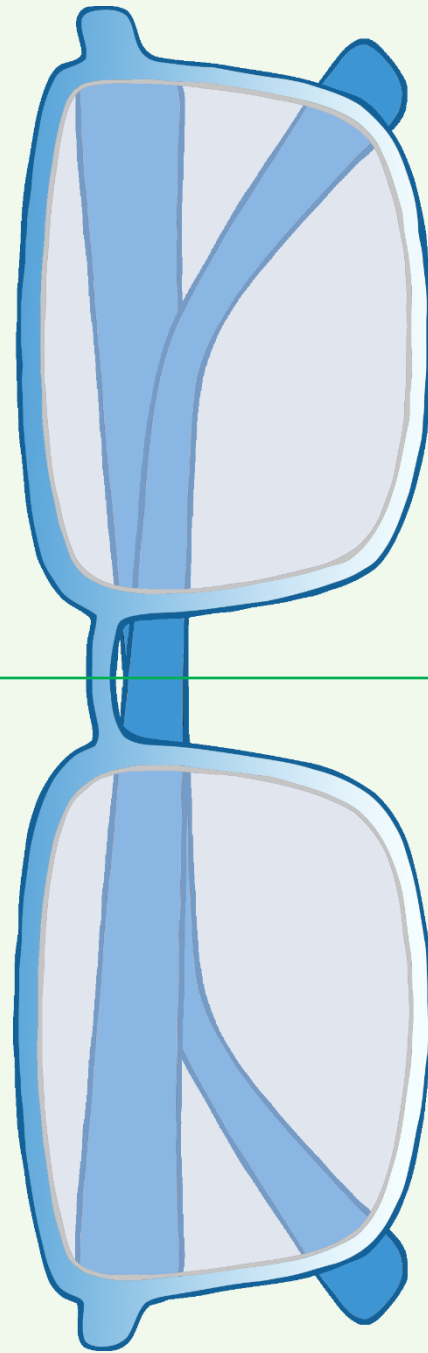

© 2023 Little Owls Resources

# Optometrist



eye drops

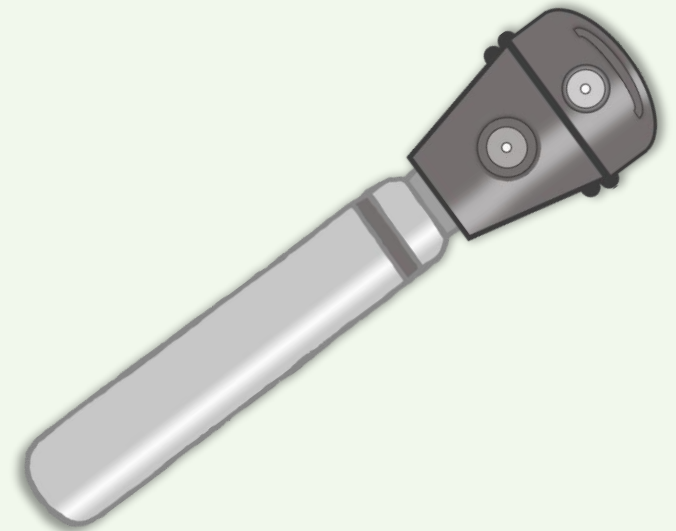

ophthalmoscope

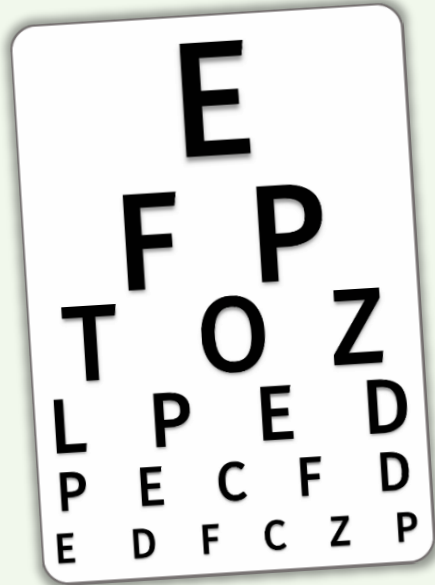

eye chart

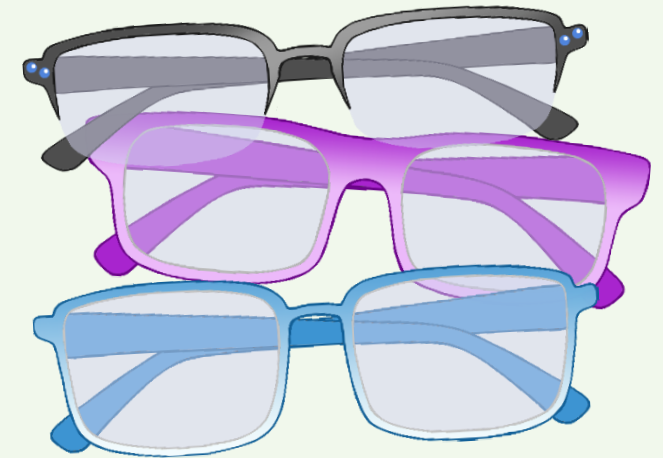
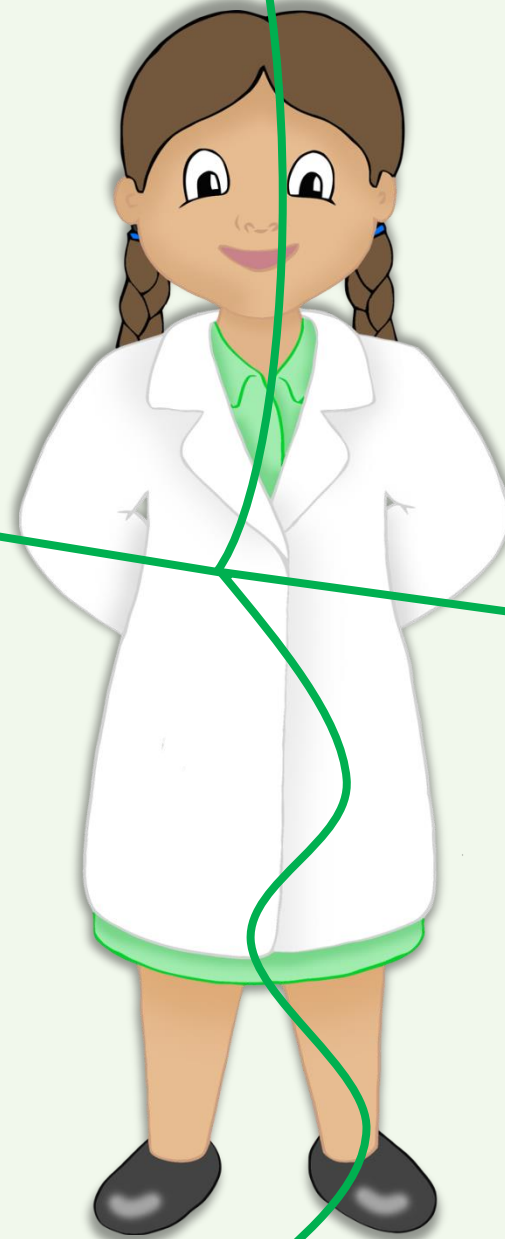

glasses